



Assets Planning and Delivery Group
Engineering

DESIGN STANDARD DS 50

Design and Construction Requirements for Gravity Sewers DN150 to DN600

VERSION 2
REVISION 4

JULY 2023

FOREWORD

The intent of Design Standards is to specify requirements that assure effective design and delivery of fit for purpose Water Corporation infrastructure assets for best whole-of-life value with least risk to Corporation service standards and safety. Design standards are also intended to promote uniformity of approach by asset designers, drafters and constructors to the design, construction, commissioning and delivery of water infrastructure and to the compatibility of new infrastructure with existing like infrastructure.

Design Standards draw on the asset design, management and field operational experience gained and documented by the Corporation and by the water industry generally over time. They are intended for application by Corporation staff, designers, constructors and land developers to the planning, design, construction and commissioning of Corporation infrastructure including water services provided by land developers for takeover by the Corporation.

Nothing in this Design Standard diminishes the responsibility of designers and constructors for applying the requirements of the Western Australia's Work Health and Safety (General) Regulations 2022 to the delivery of Corporation assets. Information on these statutory requirements may be viewed at the following web site location:

[Overview of Western Australia's Work Health and Safety \(General\) Regulations 2022 \(dmirs.wa.gov.au\)](https://dmirs.wa.gov.au)

Enquiries relating to the technical content of this Design Standard should be directed to the Senior Principal Engineer, Wastewater Conveyance Engineering, Engineering Advisory Section, Engineering. Future Design Standard changes, if any, will be issued to registered Design Standard users as and when published.

Head of Engineering

This document is prepared without the assumption of a duty of care by the Water Corporation. The document is not intended to be nor should it be relied on as a substitute for professional engineering design expertise or any other professional advice.

Users should use and reference the current version of this document.

© Copyright – Water Corporation: This standard and software is copyright. With the exception of use permitted by the Copyright Act 1968, no part may be reproduced without the written permission of the Water Corporation.

DISCLAIMER

Water Corporation accepts no liability for any loss or damage that arises from anything in the Standards/Specifications including any loss or damage that may arise due to the errors and omissions of any person. Any person or entity which relies upon the Standards/Specifications from the Water Corporation website does so that their own risk and without any right of recourse to the Water Corporation, including, but not limited to, using the Standards/Specification for works other than for or on behalf of the Water Corporation.

The Water Corporation shall not be responsible, nor liable, to any person or entity for any loss or damage suffered as a consequence of the unlawful use of, or reference to, the Standards/Specifications, including but not limited to the use of any part of the Standards/Specification without first obtaining prior express written permission from the CEO of the Water Corporation.

Any proposed dispensation from the Standards is not permitted without prior acceptance from the Standard's Custodian. Any such dispensation shall only apply to the specific project and is non-transferrable to other projects.

REVISION STATUS

The revision status of this standard is shown section by section below:

REVISION STATUS						
SECT.	VER./REV.	DATE	PAGES REVISED	REVISION DESCRIPTION (Section, Clause, Sub-Clause)	RVWD.	APRV.
1	2/0	12.06.17	All	New version/revision	ML	KP
2	2/0	12.06.17	All	New version/revision	ML	KP
3	2/0	12.06.17	All	New version/revision	ML	KP
4	2/0	12.06.17	All	New version/revision	ML	KP
4	2/1	30.06.18	38,39-40,54	CL 4.10.2 (h) – Requirement to assess sewerage network capacity and materials for engineering fitness and resistance to sewage fluids/gas, prior to proposing any injected pressure connection. CL 4.10.2 (r) - Access chamber buoyancy resistance design requirements/rules updated in greater detail. Table 4.7 Access cover materials, configuration and compliance requirements clarified.	LT	KP
4	2/2	30.06.19	26, 32-34, 37, 43, 45, 49, 56	CL 4.2.1 (e) – New clause - design flows for very high density residential areas may be guided by Perth Central Business Area flows CL 4.5 (i) – Selection of property connection type for sewers 3.5 – 5m deep revised to require assessment by designer of conditions and costs CL 4.5 (m) – Requirements for connections to DN300 and DN375 sewers clarified to include the consideration of providing a shallower parallel sewer CL 4.6.1 (k) – removed due to duplication of advice provided in 4.5 (i) CL 4.8.2.3 and 4.8.2.4 – Requirements for annulus between carrier pipe and sleeve revised	LT	KP

REVISION STATUS						
SECT.	VER./REV.	DATE	PAGES REVISED	REVISION DESCRIPTION (Section, Clause, Sub-Clause)	RVWD.	APRV.
				CL 4.10.3 (q) – removed due to duplication of text from clause (o) CL 4.12.2 (b) and (c) – clauses merged and errors fixed to clarify requirements for interconnection of PVC and vintage sewer pipes Table 4.1 – added design data for higher density zonings R220, 280, 360, 480 Table 4.7 – added a note regarding covers at pressure main discharges		
4	2/3	19/07/2022	30, 32, 33-35, 36, 41, 42, 44, 46, 49-50, 64	CL 4.2.2 (d) revised to allow access chambers CL 4.3.1 (h) added to reference sewers in basements requirements CL 4.3.7 added to define requirements for sewers in basements CL 4.5 (g) reworded CL 4.8.2.5 example drawing referenced CL 4.8.2.6 revised to extend encasement pipe 1500mm beyond road width at major crossings CL 4.8.2.7 specified that rail crossings at turnouts and level crossings are to be avoided CL 4.10.2 (m) reworded to specify that this clause applies to re-entrant angles CL 4.10.3 (c) edited to remove requirement for 90 degree maintenance shafts to also have a straight through flow CL 4.12.3 major revision to PVC pipe and fitting requirements including: addition of heavy duty fittings; the use of pressure pipe, higher stiffness pipe and wrap reinforcing to strengthen fittings; reference to table 4.10; and text rewording Table 4.10 added to clarify PVC requirements	KR/LT	KP
4	2/4	July 2023	29-30	Clause 4.2.1 (l) and (t) combined to provide better clarity		KP

REVISION STATUS						
SECT.	VER./REV.	DATE	PAGES REVISED	REVISION DESCRIPTION (Section, Clause, Sub-Clause)	RVWD.	APRV.
4	2/4	July 2023		Clause 4.8.2 rewritten for clarity		KP
4	2/4	July 2023		Clause 4.10.2 – new sub clause added to address access for sewers in undeveloped areas		KP
4	2/4	July 2023		Clause 5.2.9 removed		KP
4	2/4	July 2023		Cl 4.12.2 (a) added to require <u>new</u> pipeline components	KR	KP

5	2/0	12.06.17	All	New version/revision	ML	KP
5	2/2	30.06.19	62, 65	CL 5.1.2 – requirements for PVC pipelaying authorisation revised CL 5.2.9.2 (b) and (c) – requirements for sleeves and grouting revised	LT	KP

6	2/0	12.06.17	All	New version/revision	ML	KP

DESIGN STANDARD DS 50

Design and Construction Requirements for Gravity Sewers DN150 to DN600

CONTENTS

<i>Section</i>	<i>Page</i>
1. Introduction, Definitions, Abbreviations and Standards	10
1.1 Introduction.....	10
1.1.1 Criteria	10
1.1.2 Scope.....	10
1.1.3 Purpose.....	10
1.1.4 Drawings	10
1.1.5 Brand Names.....	10
1.1.6 Design Standards.....	10
1.1.7 Construction Standards	10
1.1.8 Access to Existing Wastewater Systems	10
1.2 Glossary of Terms	11
1.3 Abbreviations	13
1.4 Standards.....	14
2 Submission Requirements for Sewer Reticulation Designs.....	18
2.1 General.....	18
3 Drawing Requirements.....	19
3.1 Introduction.....	19
3.2 General Drawing Requirements	19
3.3 Site Plan	20
3.4 Reticulation Plans	20
3.5 Design Data Plan	22
3.6 Longitudinal Section for sewers DN375 and above.....	23
3.7 Concept Plan for MSWA submissions	23
4 Design Criteria	25
4.1 Introduction.....	25
4.2 Sewer Design.....	25
4.2.1 General.....	25
4.2.2 IS and IO Sewers.....	27
4.3 Location of Sewers in Private Property	28
4.3.1 General.....	28
4.3.2 Sewers Located Along Side Boundaries	28
4.3.3 Sewers Located Along Rear Boundaries.....	28
4.3.4 Sewers Located in Small Lots (less than 600 square metres)	28
4.3.5 Maximum Depth of Sewers in Private Property	29
4.3.6 Sewers and Property Connections Adjacent to Retaining Walls	29
4.3.7 Sewers within buildings (basements).....	29

4.4	Property Sewer Levels	31
4.5	Junctions and Property Connections	31
4.6	Location of Sewers in Road Reserves, Pedestrian Access Ways and Right of Ways	33
4.6.1	Sewers Located in Road Reserves	33
4.6.2	Sewers Located in Pedestrian Access Ways	34
4.6.3	Sewers Located in Right of Ways	34
4.7	Requirements for Easements	34
4.8	Crossings of Controlled Access Roads, Roads, Railways and Other Services	35
4.8.1	General	35
4.8.2	Trenchless Construction of Gravity Sewers	35
4.8.2.1	General	35
4.8.2.2	No Encasement Pipe Installations (carrier pipe only)	36
4.8.2.3	Encasement Pipe with an Un-grouted Annulus	36
4.8.2.4	Encasement Pipe with a Fully Grouted Annulus	37
4.8.2.5	Installation Requirements	37
4.8.2.6	Major Road Crossings	37
4.8.2.7	Rail crossings	37
4.9	Cover to Sewers	37
4.10	Access Chambers and Maintenance Shafts	38
4.10.1	General	38
4.10.2	Access Chambers	38
4.10.3	Maintenance Shafts	41
4.10.4	Deleted Access Chambers	42
4.11	Interconnection of Sewers Other Than Property Sewers	42
4.12	Pipes, Pipe Fittings and Joint Seals	43
4.12.1	Pipeline Selection Guidelines	43
4.12.2	Requirements and Limitations	43
4.12.3	PVC Pipes and Fittings	44
4.12.4	Vitrified Clay (VC) Pipes and Fittings	45
4.12.5	Reinforced Concrete Plastic Lined (RCPL) Pipes and Fittings	45
4.12.6	Ductile Iron (DI) Pipes and Fittings	45
4.12.7	Polyethylene (PE) Pipes and Fittings	45
4.12.8	Glass Reinforced Plastic (GRP) Pipes and Fittings	45
4.12.9	Elastomeric Joint Seals	46
4.13	Pipe embedment and trench fill	46
4.14	Concrete Encasement	46
5	Construction Requirements	61
5.1	Introduction	61
5.1.1	General	61
5.1.2	PVC Pipelaying Authorisation	61
5.2	Construction Requirements	61
5.2.1	General	61
5.2.2	Pipelaying	61
5.2.3	Movement Joints	62
5.2.4	Property Connections	62
5.2.5	Earthworks	62
5.2.6	Embedment	62
5.2.7	Trench Fill	63
5.2.7.1	Trench Fill under trafficable areas	63

5.2.7.2	Trench Fill under non trafficable areas	63
5.2.8	Restoration	63
5.3	Testing Requirements	64
5.3.1	General	64
5.3.2	Hydrostatic Testing of Pipelines	64
5.3.3	Air Testing of Pipelines	64
5.3.4	Ovality Testing of Pipelines.....	64
5.3.5	Infiltration in Concrete Access Chambers	65
5.3.6	Continuity Testing of Plastic Lining	65
5.4	Recording of As Constructed Data.....	65
6	As Constructed Requirements	66
6.1	Introduction.....	66
6.2	Responsibilities	66
6.3	Submission Procedures.....	66
6.3.1	General.....	66
6.3.2	Capture of Information.....	66
6.4	As-constructed Information	66
6.4.1	Sewer Details	66
6.4.2	Property Connections	67
6.4.3	Special Conditions	67
6.4.4	Sewers in Large Lots.....	67
6.4.5	Access Chambers and Maintenance Shafts	68

1. Introduction, Definitions, Abbreviations and Standards

1.1 Introduction

1.1.1 Criteria

The criteria in this Standard are subject to continuous revision. People using the Standard should ensure that they are in possession of the latest version.

1.1.2 Scope

This Standard contains the criteria and requirements for the design of gravity sewers from DN150 to DN600 and property connections.

The criteria and requirements contained in the Standard are for the design of new wastewater systems and modifications to existing systems.

1.1.3 Purpose

The Standard is intended to provide a reference for the design of gravity sewers up to DN600.

1.1.4 Drawings

The attached Drawings contain information which is complementary to the information contained in the text. The Drawings should be read in conjunction with the corresponding parts of the text.

Design Engineers and Contract Superintendents shall ensure that they have the latest issue of the Drawings.

1.1.5 Brand Names

Where a brand name is indicated, a similar material or product may be used if it has been accepted by the Water Corporation.

1.1.6 Design Standards

The Design Engineer shall be responsible for the design of the works irrespective of the requirements of this Standard which represents minimum standards.

1.1.7 Construction Standards

The information contained in this Standard represents the minimum acceptable standard and does not preclude the use of materials and workmanship of a higher standard.

1.1.8 Access to Existing Wastewater Systems

The Water Corporation's wastewater systems shall not be opened or entered without the prior approval of the Water Corporation.

1.2 Glossary of Terms

In this Standard the following words and expressions shall have the following meanings assigned to them. These meanings do not necessarily apply to the meanings given in the Water Corporation Act and other Water Corporation publications.

ACCESS CHAMBER (MANHOLE) is a chamber constructed in a sewer system in which a person can enter to inspect or maintain the sewer.

ACCESS POINT is the location at which an Access Chamber or Maintenance Shaft is to be constructed in a sewer system.

BOUNDARY TRAP is a composite fitting in a property connection or property sewer incorporating a water seal to prevent the passage of gases from the sewer to the property sewer.

CONTRACT is the agreement between the Developer and the Contractor for the execution of works.

CONTRACTOR is the person or organisation bound to execute the works under a contract.

CONTRACT PRICE is the amount payable to the Contractor for the execution of a contract.

CONTRACT SUPERINTENDENT is the Engineer appointed by the Principal to direct the Contract.

CONSTRUCTION ENGINEER is the Engineer or Engineering Firm appointed by the Developer to manage the construction of the works.

CORPORATION is either:

- The body corporate known as the Water Corporation, Western Australia, or
- A representative nominated by the Water Corporation acting on behalf of the Water Corporation.

COUNTRY AREA is the area in the state of Western Australia located outside of the boundary of the Water Corporation's Perth Region.

DESIGN DAILY FLOW is either:

- The product of the population density in residential areas, the daily flow per person and the net area, or
- The product of the flow per net hectare in non-residential areas and the net area.

DESIGN ENGINEER is the Engineer or engineering firm appointed by the Developer to design a wastewater conveyance system for submission to the Water Corporation.

DEVELOPER is the person or organisation who has entered into an agreement with the Water Corporation to provide water or wastewater infrastructure.

DISTANCE BETWEEN ACCESS CHAMBERS AND MAINTENANCE SHAFTS is the horizontal length measured between the centre points of Access Chambers and Maintenance Shafts.

EASEMENT is a defined area of land over which the Water Corporation has a right to enter for purposes defined by agreement or statute and subject to any conditions/restrictions implied therein. Such purposes can include for example, access, construction, maintenance and repair.

ENGINEER is a person qualified to be a Chartered Professional Engineer, and who has appropriate engineering experience.

ENGINEERING FIRM is an organisation which has in its employment an Engineer.

SEWER DESIGN FLOW is 1.5 times the Daily Flow.

INSPECTION OPENING (IO) is an opening in a sewer pipe or fitting sealed with a removable plug or cover and used as access for the purposes of inspection, maintenance and testing.

INSPECTION SHAFT (IS) is the vertical portion of a property connection or property sewer or IS sewer brought up to the ground surface or to within in 500 mm of the ground surface and closed with a removable plug or cover.

IO SEWER is a length of sewer which is capped at the upstream end and is connected to an Access Chamber or Maintenance Shaft at the downstream end.

IS SEWER is a length of sewer with an inspection shaft at the upstream end and a junction at the downstream end other than a property connection.

JUNCTION is the 'Y' fitting provided in a sewer to allow for the connection of a property sewer or IS sewer.

LENGTH OF IO SEWER is the horizontal length measured from the centre point of the Access Chamber or Maintenance Shaft to the end of the sewer.

LENGTH OF IS SEWER is the horizontal length measured from the intersection point of the sewers to the centre of the inspection shaft.

MAINTENANCE SHAFT is a sewer inspection fitting installed where permitted instead of an access chamber.

METROPOLITAN AREA is the area encompassed by the boundary of the Water Corporation's Perth Region.

PRINCIPAL is the person, organisation, Local Government Authority or Government Authority responsible for funding the construction of a wastewater conveyance scheme.

PROPERTY CONNECTION is the pipe and fittings built with the sewer by the Water Corporation or the Contractor to provide a connection between the property sewer and the sewer. Refer to Figures 1.2 to 1.4.

PROPERTY SEWER is the pipe and fittings built by a plumber for the householder. Refer to Figures 1.2 and 1.4.

RETICULATION SEWER is a sewer with a diameter less than 300mm.

RUNNING TRAP is a composite fitting in a Water Corporation sewer incorporating a water seal to prevent the passage of gases from a main sewer to a reticulation sewer.

SHALL is a mandatory requirement.

SHOULD is a requirement to be adopted unless circumstances justify a variation.

SUB-CONTRACTOR is a person engaged by a Contractor to execute part of the works.

SUPERVISOR is the person employed by the Contractor to be responsible for the supervision of the works. The Supervisor's minimum qualification shall be that of a licensed plumber. The Water Corporation prefers a person whose qualifications are eligibility for Graduate Membership of the Institution of Engineers, Australia. A person with extensive supervisory experience in sewer construction may be acceptable as the Supervisor.

SURVEYOR is a licensed surveyor or an engineering surveyor (eligible for corporate membership of the Institute of Mining and Engineering Surveyors).

WET GROUND is either:

- Generally any clay or loamy soil (including Pindan Sand) or
- Any ground less than 0.6m above the estimated maximum groundwater level. Refer figure 1.5.

1.3 Abbreviations

In this Standard the following abbreviations shall have the meanings assigned to them below:

AHD	Australian Height Datum
AC	Access Chamber
AS	Australian Standard
CAR	Controlled Access Road
CI	Cast Iron
Dia.	Diameter
DI	Ductile Iron
DN	Nominal Diameter (e.g. DN150, DN225, DN300, etc)
Fig.	Figure
GRP	Glass-fibre Reinforced Plastic
IO	Inspection Opening
IS	Inspection Shaft
L/s	Litres per second
PAW	Pedestrian Access Way
PE	Polyethylene
PN	Nominal Pressure Classification (e.g. PN 9, PN 12, PN 16 etc)
POS	Public Open Space
PVC	Polyvinyl Chloride
RCPL	Reinforced Concrete Plastic Lined
ROW	Right of Way
SN	Nominal Stiffness Classification (e.g. SN 6, SN 8, SN 16 etc)
VC	Vitrified Clay

(Nominal diameter, stiffness and pressure classifications shall be as defined in the relevant Standards)

1.4 Standards

The following Australian Standards are referred to in this Standard, the list may not be exhaustive.

AS/NZS 1260	PVC-U pipes and fittings for drain, waste and vent applications
AS/NZS 1477	PVC pipes and fittings for pressure applications
AS/NZS 1554.1	Structural steel welding -Welding of steel structures
AS/NZS 1554.6	Structural steel welding-Welding stainless steels for structural purposes
AS 1646	Elastomeric seals for waterworks purposes (incorporating AS/EN 681)
AS 1744	Forms of letters and numerals for road signs (Known as standard alphabets for road signs)
AS/NZS 2032	Installation of PVC pipe systems
AS 2082	Visually stress-graded hardwood for structural purposes
AS/NZS 2280	Ductile iron pressure pipes and fittings
AS/NZS 2566.1	Buried flexible pipelines Part 1: Structural design
AS/NZS 2566.2	Buried flexible pipelines Part 2: Installation
AS 2758.1	Aggregates and rock for engineering purposes-Concrete aggregates
AS 3571.1	Plastics piping systems - Glass-reinforced thermoplastics (GRP) systems based on unsaturated polyester (UP) resin - Pressure and non-pressure drainage and sewerage
AS 3600	Concrete structures
AS/NZS 3725	Design for installation of buried concrete pipes
AS 3735	Concrete structures retaining liquids
AS 3894.1	Site testing of protective coatings – Non-conductive coatings – Continuity testing – High voltage (bruch) method
AS 3996	Access covers and grates
AS 4058	Precast concrete pipes (pressure and non-pressure)
AS/NZS 4129	Fittings for polyethylene (PE) pipes for pressure applications
AS/NZS 4130	Polyethylene (PE) pipes for pressure applications
AS/NZS 4131	Polyethylene (PE) compounds for pressure pipes and fittings
AS/NZS 4158	Thermal-bonded polymeric coatings on valves and fittings for water industry purposes
AS 4198	Precast concrete access chambers for sewerage application
AS/NZS 4441	Oriented PVC (PVC-O) pipes for pressure applications
AS/NZS 4671	Steel reinforcing materials
AS/NZS 4680	Hot-dip galvanised (zinc) coatings on fabricated ferrous articles
AS/NZS 4765	Modified PVC (PVC-M) pipes for pressure applications
AS/NZS 4799	Installation of underground utility services and pipelines within railway boundaries
AS/NZS 5065	PE & PP pipes and fittings for drainage and sewerage application
BS EN 13923	Filament-wound FRP pressure vessels. Materials, design, manufacturing and testing
EN 1465	Adhesives—Determination of tensile lap-shear strength of bonded assemblies
WSA 137	Maintenance shafts and maintenance chambers for sewerage

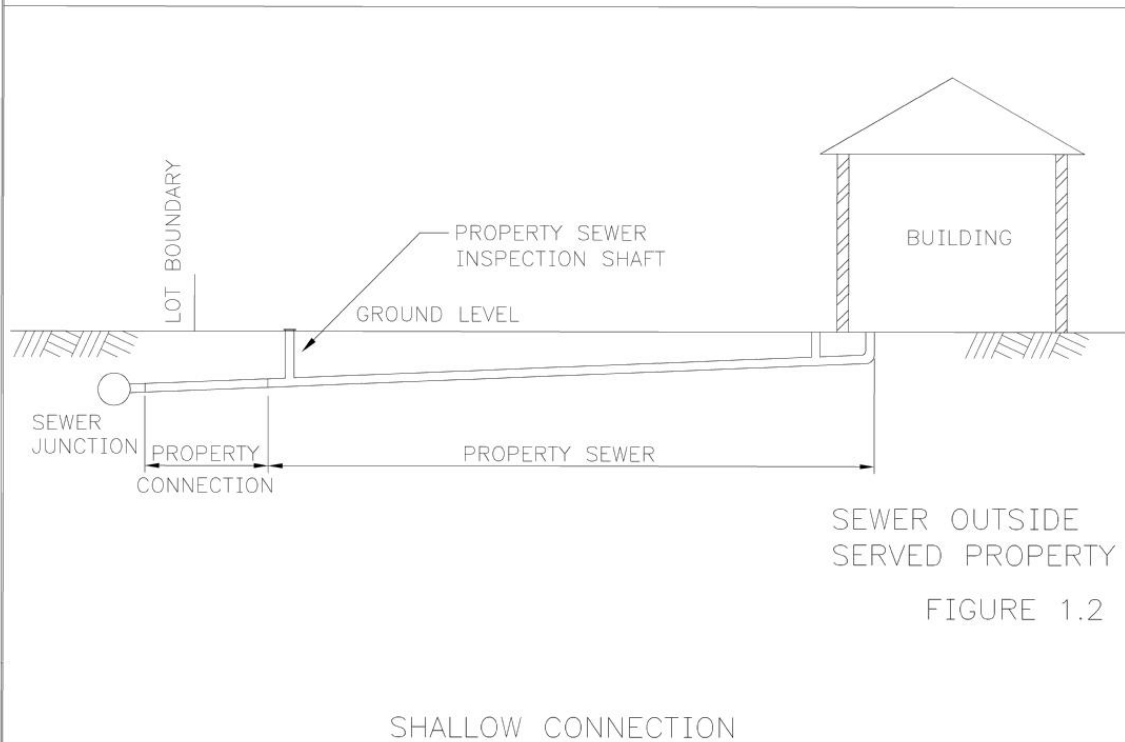
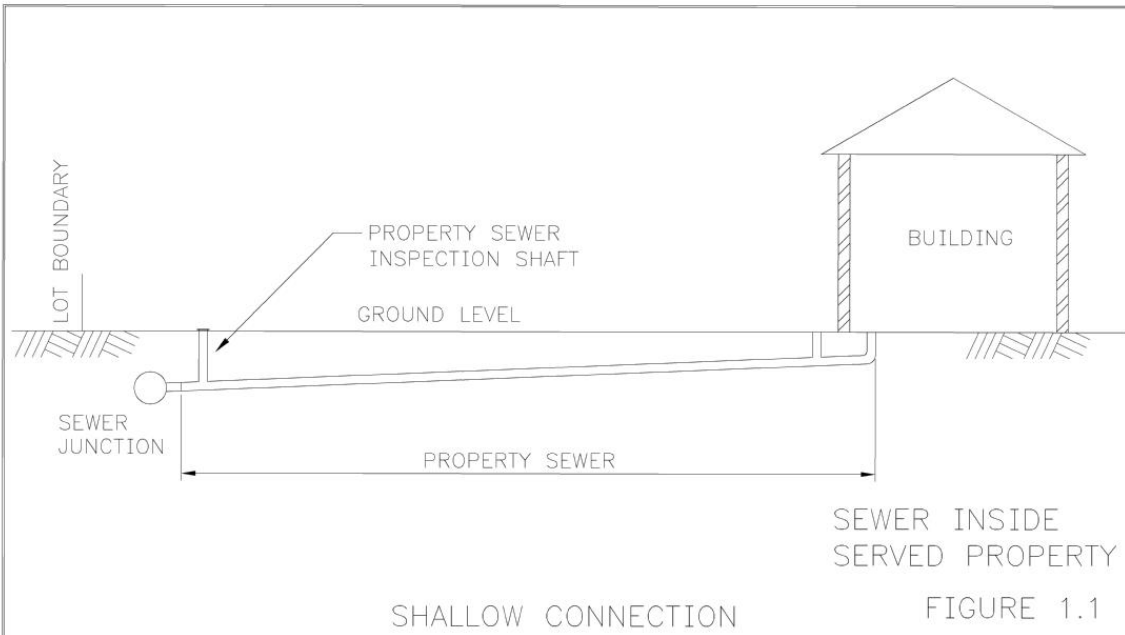

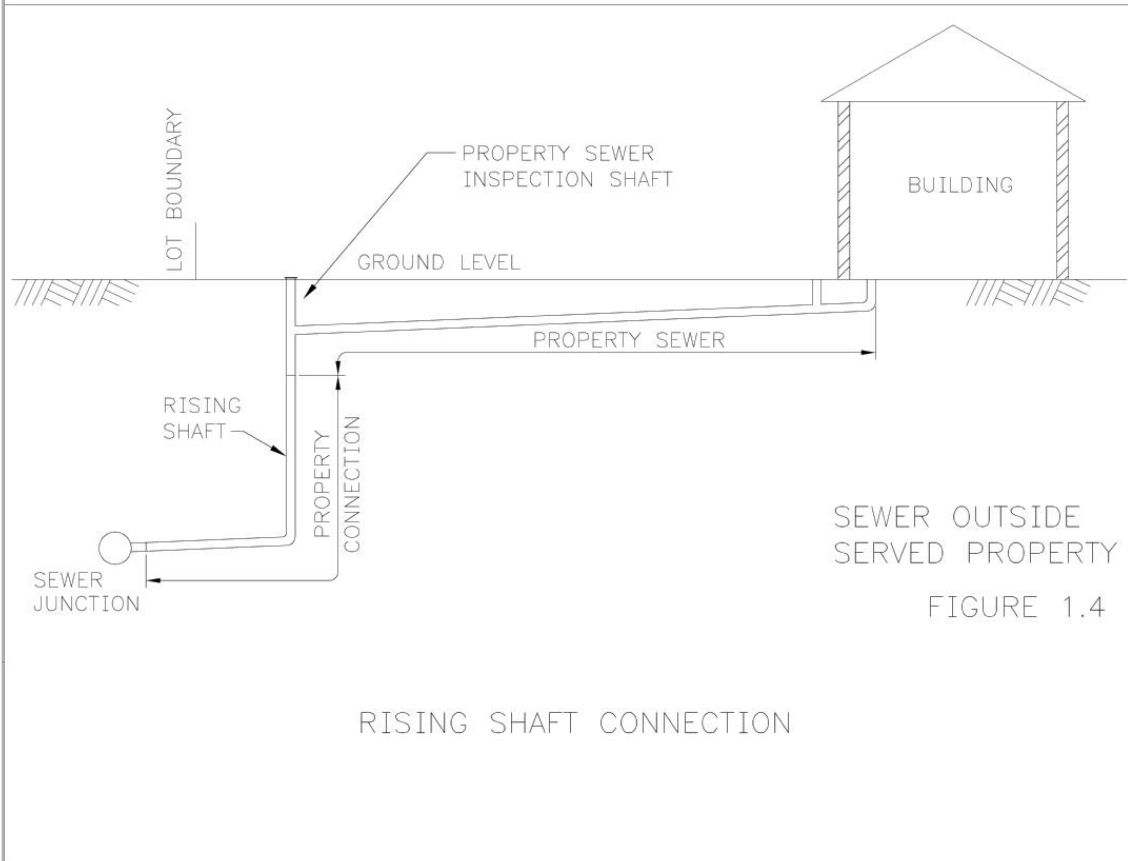
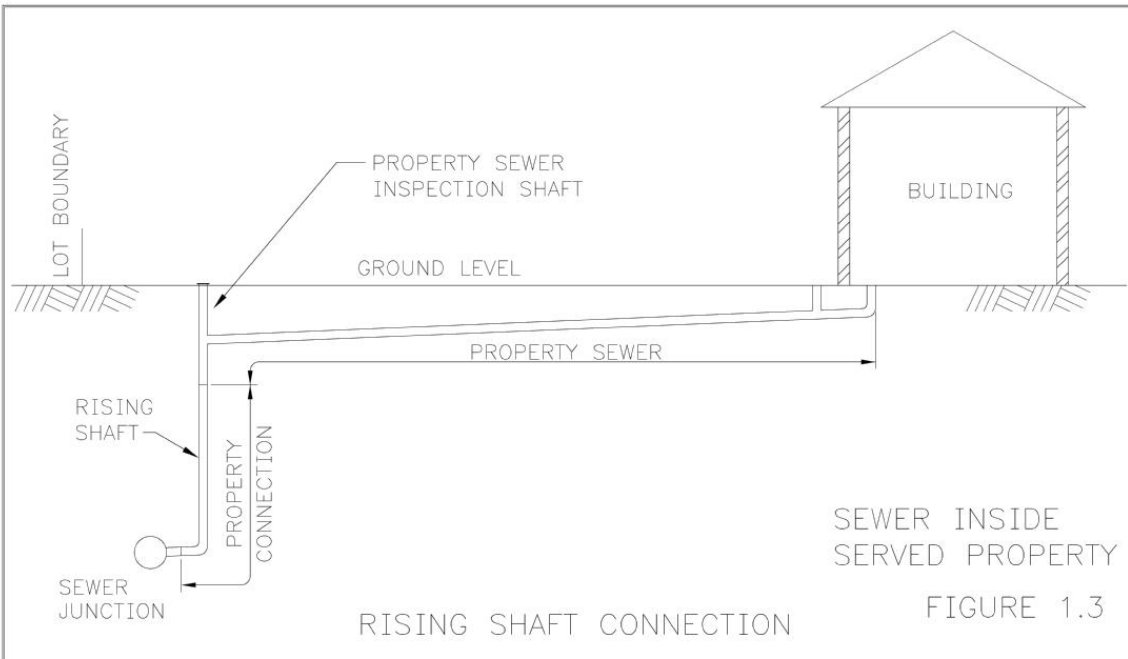

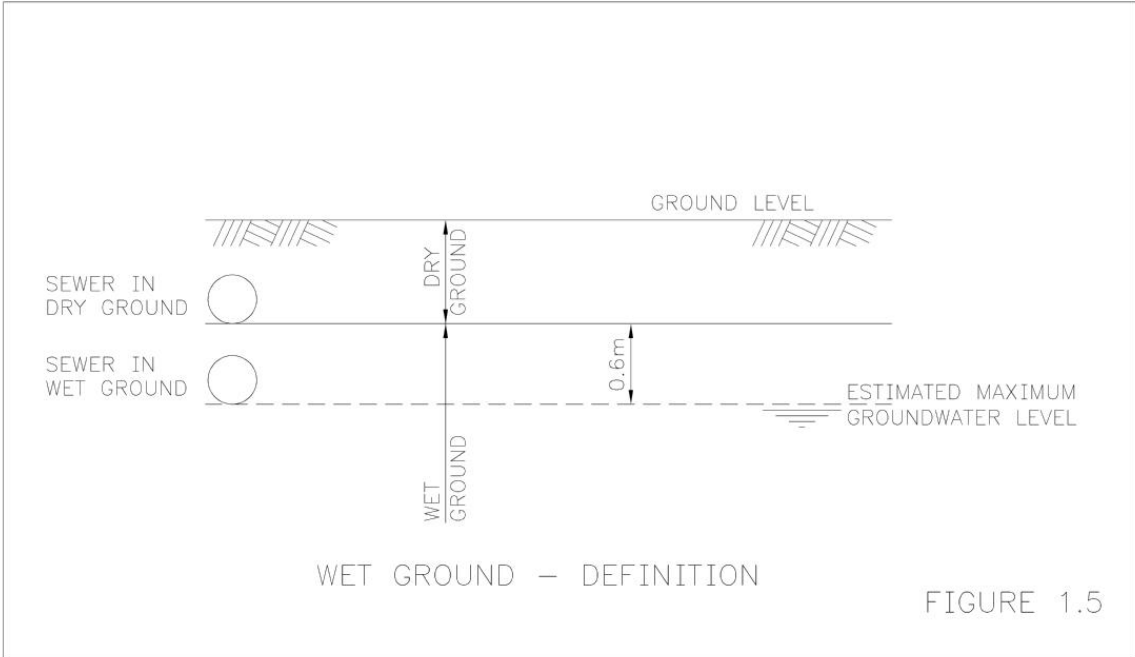

FIGURE 1.5

2 Submission Requirements for Sewer Reticulation Designs

2.1 General

- a. Works undertaken for a developer and sewer extensions not involving land subdivision shall be submitted to the Water Corporation in accordance with the requirements of the “Developers Manual”.
- b. Works commissioned by the Water Corporation shall be submitted to the Water Corporation in accordance with the requirements of the commissioning brief.
- c. The following information will be provided by the Water Corporation after the initial submission has been received, the information shall be shown on all further submissions.
- d. DEVELOPMENT SUBMISSIONS
 - Access Chamber and Maintenance Shaft numbers.
 - Planset number.
 - Water Corporation file number.
 - Design appraisal form.
- e. WATER CORPORATION COMMISSIONED
 - Access Chamber and Maintenance Shaft numbers.
 - Reticulation Area and planset number & title.
 - Drawing numbers on request.
 - Water Corporation file number.
 - Project number.

3 Drawing Requirements

3.1 Introduction

This section of the Standard specifies the Corporation's requirements for the preparation of design drawings for the construction of gravity sewers.

For Water Corporation Capital Projects, drawing submissions shall be in accordance with the requirements of this Standard, DS80 and the design brief for the project.

3.2 General Drawing Requirements

DEVELOPMENT SUBMISSIONS

- a. Drawings shall be similar to the examples contained in this Standard. The drawings shall comply with the requirements of this Clause and contain all the data shown on the examples if relevant to the particular project in hand.
- b. Drawings produced for sewer reticulation designs for the Corporation shall be in accordance with AS 1100, Part 101 and drawn on A1, A2 or A3 sheets.
- c. Each drawing prepared by the design engineer shall carry a suitable company identification logo or similar within or as close to the title block as possible, the name of the developer and a sign off box as shown on the example drawings.
- d. Drawings submitted to the Water Corporation shall be in accordance with the Water Corporation’s DS 80, WCX CAD Standard Water Corporation eXternal (WCX) Manual.

WORKS AGREEMENT SUBMISSION

- a. The drawings shall be submitted as per the development submissions with the following additional drawings and inclusions.
 - i A concept plan shall be submitted prior to the establishment of the agreement. This plan shall have a sign off box as shown on example drawing AA01-2-1.
 - ii The drawings submitted for each stage shall include a sign off box with the following wording instead of the sign off box shown on the example drawings.

This plan is received as being in accordance with the endorsed MSA concept plan xxxx-xx-xxx-xxx.
 Compliance with this concept plan and Water Corporation Standards has not been checked and remains the responsibility of the Design Engineer.
 Received Land Servicing Branch

WATER CORPORATION COMMISSIONED

- a. Drawings shall be similar to the examples contained in this Standard. The drawings shall comply with the requirements of this Clause and contain all the data shown on the examples if relevant to the particular project in hand.
- b. Drawings produced for sewer reticulation designs for the Corporation shall be in accordance with AS 1100, Part 101 and drawn on A1, A2, A3 or A4 sheets.
- c. Drawings submitted to the Corporation shall be on Water Corporation standard drawing sheets. Standard drawing sheets will be supplied to the Design Engineer in electronic form with the DS 80, WCX (Water Corporation eXternal) CAD Standard download.
- d. Drawings submitted to the Water Corporation shall be in accordance with the Water Corporation’s DS 80, WCX CAD Standard Water Corporation eXternal (WCX) Manual.

- e. The WCX Download can be obtained from the Document Control Officer at Engineering.StandardsEnquiries@watercorporation.com.au.

3.3 Site Plan

- a. The plan shall be similar to Drawing AA01-1-1.
- b. The scale should be 1:2000.
- c. The plan shall include the following information:
 - i. The direction of north, which should have the same orientation as the reticulation plans.
 - ii. Existing and proposed sewers which shall be separately identified.
 - iii. The diameter of existing and proposed sewers.
 - iv. Access Chambers, with numbers.
 - v. Maintenance Shafts, with numbers.
 - vi. Approximate depth of sewer at Access Chambers and Maintenance Shafts.
 - vii. Street names, cadastral boundaries and lot numbers.
 - viii. In new subdivisions, lots containing buildings which require a service, shall be indicated with a “B.”
 - ix. Works required to connect the area to the existing wastewater system.
 - x. The boundary of the reticulation area.
 - xi. Names of the relevant Local Authorities and boundaries if applicable.
 - xii. The total length of each diameter of sewer.
 - xiii. Numbers of lots being served.
 - xiv. Number of Access chambers.
 - xv. Number of Maintenance Shafts.
 - xvi. The Corporation file number and the Reticulation Area and plan number shall be entered in the title block. The project number shall also be entered on Water Corporation Capital Projects
 - xvii. The estimated maximum ground water level.
 - xviii. A grid to the same scale as the site plan indicating the layout and numbers of the reticulation plans.

3.4 Reticulation Plans

- a. The plans shall be similar to Drawing AA01-3-2.
- b. The scale shall be 1:500 or 1:1000.
- c. The plans shall include the following information:
 - i. The direction of north, which should be aligned towards the top and parallel to the side of the plan.
 - ii. An index grid accentuating the plan being viewed and showing all the adjoining plans.
 - iii. Street names, cadastral boundaries and lot numbers.
 - iv. House numbers shall be shown on Water Corporation infill projects
 - v. Special land use other than single residential, e.g. duplex, POS, school, multiple residential.
 - vi. The boundary of the reticulation area.
 - vii. Existing sewers serving all lots adjacent to the submitted area.

- viii Full details of existing sewers to which the proposed sewers will be connected between the point of connection and at least the second Access Chamber or Maintenance Shaft downstream.
- ix All proposed sewers with the following details:
 - A notation indicating where a particular type of pipe material is mandatory.
 - Diameter of pipe.
 - Grade of sewer.
Grades of 1:50 and steeper shall be shown to the nearest 0.m.
Grades flatter than 1:50 shall be shown to the nearest whole number.
 - Invert levels shall be shown to the nearest 0.01m.
 - Distances between Access Chambers and Maintenance Shafts.
The lengths of IO and IS sewers.
The above dimensions shall be to the nearest 0.1m.
 - Location of running traps
- x Sewer alignments and position of Access Chambers and Maintenance Shafts.
- xi Easement location and dimensions where applicable.
- xii Access Chamber and Maintenance Shaft details consisting of the number supplied by the Water Corporation for the Access Point following the initial submission proposal. The type of Access Point and whether there is a drop at the Access Point.
- xiii Details of alternative servicing options
 - The extent and level of any fill.
 - Areas of lots that cannot be served at 1:60.
 - Alternative plumbing options.
- xiv The position of all property connections showing:
 - Special connection details.
 - The diameter of any property connection larger than DN100.
 - A notation where boundary traps are required.
- xv Ground level data showing:
 - The latest available contours based on the Australian Height Datum with a maximum interval of 1.0m for plans to a scale of 1:1000 and 0.5m for plans to a scale of 1:500.
 - The extent and level of any fill.
 - Contours for proposed earthworks.
 - Road levels, where substantially different from the natural surface.
- xvi The extent of concrete encasement.
- xvii Invert levels, sizes and positions of existing and proposed services and obstructions.
- xviii Where any part of a lot is not capable of being served or if a minimum floor level will apply to any development on a lot, this shall be clearly indicated on the Reticulation Plans, i.e. canal developments.
- xix The Water Corporation file number and the project number shall also be entered on Water Corporation Capital Projects. Reticulation Area and plan number shall be entered in the title block.

3.5 Design Data Plan

- a. The plan shall be similar to Drawing AA01-2-1.
- b. The scale should be 1:2000.
- c. The plan shall indicate the basis of design for the reticulation area being submitted and shall show the following information:
 - i. The direction of north, which should have the same orientation as the reticulation plans.
 - ii. Routes of proposed sewers.
 - iii. The diameter of proposed sewers above DN150.
 - iv. Street names, cadastral boundaries and lot numbers.
 - v. Boundaries of each of the internal sub-catchments included in the reticulation area, marked in a clearly distinguishable manner. The area of sub-catchments should be approximately 10 hectares.
 - vi. Wet or dry areas defined by shading, hatching or other means.
 - vii. Flow direction and volume at each design point indicated by an arrowhead on the sewer line and a number giving the flow in litres per second. Indicated flows at each design point along a run of sewer shall be cumulative.
 - viii. Flow data for each sub-catchment with dry and wet areas or different zonings separately.
 - ix. For residential areas data shall be in the form 1.3-52.5 / 180-0.21 where the figures represent in order:
 - The net area in hectares.
 - The number of persons / net hectare.
 - The flow in litres / person/day.
 - The Sewer Design Flow in litres/second generated within the sub-catchment
 - For non-residential areas data shall be in the form 0.85-14976-0.22 where the figures represent in order:
 - The net area in hectares.
 - The flow in litres / net hectare / day.
 - The Sewer Design Flow in litres/second generated within the catchment.
 - x. Entry points for all gravity flows originating in the overall catchment outside the reticulation area being designed.

At each entry point the total net dry and wet areas, the Residential Code zonings and the Sewer Design Flow rate shall be given.

 - i. Entry points for all flows pumped into the area.

At each entry point the total net contributing area, Sewer Design Flow to the pumping station and the pump rate shall be given.
 - ii. The total net area in hectares within the reticulation area.
 - iii. The total Sewer Design Flow to the outfall sewer from the reticulation area or to the pumping station in litres per second.
 - iv. For areas with external flows a summary of the catchment area, external areas or pumped flows (with area description e.g. Area 2A, future area) with the net contributing area, GSDF (and pump rate if applicable) and a total GSDF.

- d. The Water Corporation file number and the Reticulation Area and plan number shall be entered in the title block. The project number shall also be entered on Water Corporation Capital Projects.

3.6 Longitudinal Section for sewers DN375 and above

- a. The scale should be 1:1000 or 1:500 horizontally and 1:100 vertically.
- b. The plan shall include but not be limited to:
 - i. The direction of north.
 - ii. Street names, cadastral boundaries and lot numbers
 - iii. Full details of existing sewers to which the proposed sewers will be connected between the point of connection and at least the second Access Chamber or Maintenance Shaft downstream.
 - iv. Access Chambers, with numbers.
 - v. Existing and proposed surface levels.
 - vi. Chainages.
 - vii. All proposed sewers with the following details:
 - Pipe material, pressure and stiffness classification.
 - Diameter of pipe.
 - Grade of pipe.
Grades of 1:50 and steeper shall be shown to the nearest 0.1m.
Grades flatter than 1:50 shall be shown to the nearest whole number.
 - Invert levels shall be shown to the nearest 0.01m.
 - Sewer alignments and position of Access Chambers.
- a. Drawings submitted to the Water Corporation shall be in accordance with the Water Corporation's publication DS80, WCX CAD Standard Water Corporation eXternal (WCX) Manual.

3.7 Concept Plan for MSWA submissions

- a. The Concept plan shall consider at a minimum.
 - i. The catchment control levels (cut and fill etc.)
 - ii. The interconnection with both the existing network and the future network of other developments for both reticulation and distribution assets.
 - iii. The routes and location of all Headworks, and/or outfall assets.
 - iv. The routes of all reticulation assets.
 - v. The isolation of existing works strategy for the various stages of construction.
 - vi. Controlling sewer lines shall be identified with inverts and grades.
 - vii. All other control points which may influence designs.
 - viii. Street names and cadastral boundaries.
 - ix. Spot levels for final development.
 - x. Sewer design flow to be shown where there is a change of pipe size or use of minimum grades
 - xi. Proposed stage boundaries

- xii. MSHA area boundary
- xiii. Locality plan and WAPC plan at reduced scale e.g. 1:10000

4 Design Criteria

4.1 Introduction

This part of the Standard sets out the criteria to be used in the design of gravity sewers.

- a. The design shall comply with the Water Corporation's overall planning for the area and provision shall be made to connect adjoining areas as required.
- b. Where required for possible future extensions, sewers shall extend to the boundary of the area being served to suit the ultimate planning of the Water Corporation. Where the future connection will be through public land the sewer shall be extended into the public land. The length to be extended shall be discussed with the Water Corporation.
- c. Where a sewer will be constructed alongside the boundary of the area being served, property connections shall be constructed into the adjoining land to serve existing lots or possible future subdivisions if the lot layout is known.
- d. Survey data used for design shall be checked against the invert level of the existing sewer at the point of connection.
- e. Wastewater schemes shall be designed so that land will be seweraged by a gravity scheme in preference to pumping scheme.
- f. Sewers shall be designed to permit property sewers to be constructed in compliance with the relevant plumbing By-laws.

4.2 Sewer Design

4.2.1 General

- a. The design flow in sewers shall include the wastewater flow from the design population contributing to the sewer and an allowance for stormwater and groundwater infiltration and approved industrial flows or special peak flows where appropriate.
- b. The Local Authority's current or proposed Residential Planning Code (R Code) which indicates the number of dwellings per net hectare in any area, together with the anticipated number of persons in each dwelling shall form the basis for the calculation of contributing populations.
- c. A Residential Planning Code of R15 shall be used where the Local Authority Code is less than R15 or where no Code exists.
- d. Wastewater design flows shall be calculated from the data shown in Tables 4.1, 4.2 and 4.3. The data shown in these tables represent minimum requirements. Where special factors or local information indicate the possibility of higher flows these shall be individually assessed.
- e. The calculation of wastewater design flows for residential areas with higher population densities than the highest densities listed in Tables 4.1 and 4.2 may be guided by the Perth Central Business Area design flow in Table 4.3.
- f. The basis for calculating flows from town and city centres other than Perth shall be evaluated in each case.
- g. The Daily Flow from a residential area shall be the product of the population density, the daily flow per person and the net area.
- h. The Daily Flow from a non-residential area shall be the product of the flow per net hectare and the net area.
- i. The Sewer Design Flow shall be 1.5 times the Daily Flow, unless special factors or local information indicate the possibility of higher flows which shall be individually assessed.

- j. In areas where there is an existing or proposed subdivision plan the net area shall be the total area of the individual lots that can be connected to the wastewater system.
- k. When broadacre catchments are being evaluated the net area for the application of zoning densities shall be obtained by deducting the area of large recreation reserves and major roads from the gross area and reducing the remaining area by 25% to allow for public open space and minor roads.
- l. Sewers serving a gravity area shall be designed to carry the Sewer Design Flow. When pumped flows are discharged into a gravity sewer, the gravity sewer shall be designed to accept the pumped flow rate plus the Sewer Design Flow from any gravity area contributing to the discharge point of the catchment, noting that the minimum size of a sewer receiving the discharge from a pressure main shall be DN225 unless otherwise approved by the Water Corporation.
- m. At these flows the depth of flow in the sewer shall be not more than:
 - i. Half full for DN150 pipes
 - ii. Two thirds full for DN225 and larger pipes.
- n. The minimum size of sewers in residential areas and serving small commercial areas and shopping centres shall be DN150. Where the Gravity Sewer Design Flow is at least 3L/s a DN225 sewer at 1:300 grade may be used.
 - i. Small commercial areas and shopping centres are defined as areas/centres not exceeding 0.5 hectares.
- o. The minimum size of sewers serving industrial, light industrial, large commercial areas and large shopping centres shall be DN225 with the following exceptions:
 - i. Single lots in industrial and commercial subdivisions can be served by a DN150 sewer provided that the area of the single lots does not exceed 0.5 hectares.
 - ii. A DN150 sewer can serve two industrial or commercial lots or an industrial and a commercial lot provided that the combined area of the two lots does not exceed 0.5 hectares.
- p. Pipe diameters with corresponding minimum and maximum grades, maximum distances between access chambers and the maximum allowable flows within various ranges of grades are shown in Table 4.4.

The flow capacity of pipes is based on the Colebrook-White equation using a roughness coefficient (“k”) of 1.0mm.

Where the grade is required to be steeper than the minimum because of flow requirements it shall be marked on the drawing as the minimum grade allowable

- q. The minimum grades shown in Table 4.4 may be varied as follows:
 - i. The minimum grade of a DN150 sewer may be reduced to 1:250 provided that one of the following is achieved:
 - ii. There is a reduction in the number of permanent pumping stations through which the flow discharges.
 - iii. The area is drained to a gravity sewer rather than to a pumping station.
 - iv. The number of entries to sewers DN300 and larger is reduced.
- r. The minimum grade of a DN225 sewer may be reduced to 1:350 where a pumping station discharges at least 14L/s into the sewer.
- s. When serving industrial, light industrial, large commercial areas and large shopping centres the DN225 sewer shall be constructed at a minimum grade of 1:200 if the Sewer Design Flow is less than 3 L/s.
- t. The maximum and minimum grades of sewers are shown in Table 4.4.

- u. Where the discharge rate of a pressure main exceeds two thirds of the capacity of a receiving gravity sewer the system design is to be discussed with the Water Corporation.
- v. The diameter of a sewer downstream of any point should not be reduced.
- w. The centre lines of all sewers entering or leaving an Access Chamber should intersect at the centre point of the Access Chamber in plan unless the Access Chamber is a re-entrant Access Chamber.

4.2.2 IS and IO Sewers

- a. The maximum length of IO sewers shall be 100m and the min. grade shall be 1:200.
- b. To assist with sight inspections IO sewers shall be provided with end caps on which the internal face is reflective to light. The internal face of the cap can be made reflective by either the use of reflective adhesive tape or painting with PVA paint.
- c. IO sewers crossing road reserves to service properties should be terminated within the road reserve 0.5m from the property boundaries. IO sewers may be terminated up to 1.5m within properties if problems will be encountered with other services or retaining wall foundations as shown in AA01-86-5.
- d. A maximum 45 m long IO sewer can be extended off an existing IS sewer. The IO sewer shall be connected to the IS sewer with a maintenance shaft or an access chamber. This arrangement is only allowed off existing sewers as shown in AA01-86-5 and is not allowed off new sewers in developments.
- e. Where Access Chambers or Maintenance Shafts are available, IO sewers shall be used in preference to IS sewers.
- f. Where a sewer terminates within the rear or the side of a served property, an IO sewer shall be used in preference to an IS sewer. Where an IO sewer cannot be constructed in lieu of an IS sewer, the IS shall be brought to the surface and fitted with a cover unless the IS can be used as property connection (P9) in which case the shaft can be left below the surface as shown in drawing AA01-86-1.
- g. IS sewers shall be DN150 or DN225 PVC and are permitted off sewers up to DN375.
- h. IS sewers can be designed at any angle 90° and larger to the downstream sewer provided standard fittings are used. Return angles (less than 90° to the downstream sewer) are not permitted because of rodding difficulties.
- i. Where an IS sewer is constructed off an IO sewer, the connection point of the IS sewer to the IO sewer shall be in public land if the IS sewer is longer than 7.0 m.
- j. The maximum length of IS sewers shall be 50m and the minimum grade shall be 1:100.
- k. Where an IS on an IS sewer is located beneath a paved area the IS shall be brought to the surface and provided with a cover. IS in driveways shall also be brought to the surface and provided with a cover.
- l. Drop junctions on IS sewers shall only be used with prior approval of the Water Corporation when it is impracticable to grade the IS sewer down to the reticulation sewer.
- m. DN150 and DN225 IS sewers may be graded steeper than 1:5 to avoid drop junctions on the sewer.
- n. IS shall be brought to within 5 degrees of vertical. This can be achieved by the use of additional bends as shown on AA01-86-1.
- o. IS sewers crossing road reserves to service properties shall be terminated 1.5m within the property boundary unless they will be brought to the surface to be used as a property connection (P9) as shown in AA01-86-1 in which case IS sewers shall be terminated 0.5m within the property boundary.
- p. IS sewers with a P9 connection shall have a minimum depth to invert of the property connection level plus 800mm. If the grade of the sewer requires an additional bend on the inspection shaft to bring it to within 5 degrees of vertical, the minimum depth to invert is the property connection level plus 1200mm, as shown in AA01-86-1.

4.3 Location of Sewers in Private Property

4.3.1 General

Where possible sewers shall be located in public land.

- a. Sewers DN300 and DN375 shall not be located in private land without prior Water Corporation approval.
- b. Sewers larger than DN375 shall be located in public land.
- c. When designing a sewer through private property in developed areas, obstructions such as sheds, brick walls, swimming pools, garages and large trees shall be avoided, where possible, when determining the route of the sewer.
- d. If a property boundary is not clearly defined as a side or rear boundary it shall be considered as a side boundary.
- e. A sewer should not be located along more than one boundary within a lot.
- f. The location and orientation of Access Chambers shall permit the removal of covers without being restricted by existing or proposed fences and retaining walls.
- g. When a property is served from a sewer located in adjacent private property the maximum length of property connection permitted in adjacent private property shall not exceed 1.8m without the provision of an easement.
- h. When designing a sewer within a building (basement), additional requirements apply as detailed in Clause 4.3.7.

4.3.2 Sewers Located Along Side Boundaries

- a. The normal alignment for sewers in private property should be 0.7m except where Access Chambers are involved in which case the alignment should be 1.0m. (If a maintenance shaft is used the alignment should be 0.7m).
- b. If the fall across a lot exceeds 1.0m the sewer should be located in the higher lot.
- c. The alignment of a sewer shall make allowance for the erection of a power pole by the electricity supply authority in the road reserve on the projected line of the boundary.

4.3.3 Sewers Located Along Rear Boundaries

- a. The normal alignment for sewers in private property should be 1.0 m. The alignment shall not exceed 1.8 m without the provision of an easement.
- b. Where properties on both sides of a common boundary are to be served from the rear, the sewer should be located on the lower side of the boundary.
- c. Where properties on only one side of a common boundary are to be served from the rear, the sewer should be located inside the properties being served.

4.3.4 Sewers Located in Small Lots (less than 600 square metres)

- a. Sewers shall only be located within small lots when it is impracticable to locate the sewers under the road reserve or in public land.
- b. Sewers shall not be located in small lots without prior Water Corporation approval.

4.3.5 Maximum Depth of Sewers in Private Property

- a. The depth of a sewer in private property should not exceed 3.0m to invert unless the Water Corporation considers that there will be an improvement to the design of the sewer system by having a greater depth in some sections.
- b. The maximum depth of a sewer in residential property shall not exceed 5.0m to invert.

4.3.6 Sewers and Property Connections Adjacent to Retaining Walls

- a. Property lots shall not be served from the rear boundary by running a sewer parallel to a retaining wall.
- b. Where property lots are to be served from the front boundary with the sewer running parallel to retaining walls, the preferred location of property connections shall be under the private property driveways with the shafts brought to the surface and fitted with a cover as shown on drawing AA01-86-1.
- c. Under special circumstances, the Water Corporation may consider an alternative arrangement for installing property connections near a retaining wall if it can be demonstrated that there is no better option available and that the Design Engineer has designed the sewer and the connections for the relevant loads including the imposed load of the retaining wall and that there is adequate access to allow excavation for any repair works.
- d. The Design Engineer shall submit their design to the Water Corporation for consideration and approval.

4.3.7 Sewers within buildings (basements)

- a. Laying reticulation sewers within building basements shall only be permissible where it proves impracticable to relocate the sewer around the property or building footprint perimeter, as determined in consultation with the Water Corporation.
- b. Building plans shall have due regard to Water Corporation sewer requirements as defined in this standard.
- c. Sewers larger than DN225 shall not be constructed in basements due to the additional operational and public health and safety risks associated with main sewers.
- d. The alignment of sewers in basements should
 - i. Minimise the need for bends
 - ii. Provide for Water Corporation access to the pipe
 - iii. Provide adequate separation from other services, with 150mm clearance maintained around the pipe
 - iv. Consider the consequences of sewer surcharge events
 - v. Prevent and/or consider the consequences of failure due to fire or third party damage to the sewer
 - vi. Ensure adequate ventilation is maintained (to reduce risks associated with gases that may be released from the sewer, for example in the event of a pipe failure).
- e. Building and basement design shall consider the flow path for wastewater in the event of an overflow or pipe failure. Overflow flow paths should be shown on design drawings.
- f. Access chambers or maintenance shafts shall be placed at bends where these are unavoidable, and at junctions, including where there is provision for future sewer connections, and shall:
 - i. Be located outside the building wherever possible
 - ii. Be adequately supported by the building
 - iii. Be brought up to ground level and be provided with an access cover which is open to the sky and provides 24/7 access for Water Corporation as per 4.3.7(h). Access covers are not

- allowed in basements or within buildings due to the risks associated with hazardous gases and overflows during surcharge events.
- g. Within buildings, maintenance shafts that are continuously solvent welded are preferred, to minimise the risk of leaks during sewer surcharge events, however they must be encased in concrete.
 - h. Water Corporation require 24 hour safe access to sewers in basements and any associated access points (access chambers and maintenance shafts) at ground level, and proponents shall ensure:
 - i. Access to the pipe is not obstructed by walls, beams or columns
 - ii. A minimum clearance of 150 mm is maintained between the outside of the pipe and any building element
 - iii. Access arrangements for Water Corporation are agreed and documented in the Strata Scheme Documents or similar, with keys or access cards provided if necessary
 - iv. Access details are shown on design drawings
 - v. A clear working area for workers and equipment shall be provided around access covers of 2 m all around and 2.4 m headroom above the cover. Vehicle access shall be provided within 50 m of access covers for hoses and maintenance equipment to be used. This may require a dedicated parking zone or clearance area for maintenance vehicles (to be shown on the design drawings).
 - i. Pipelines within basements shall:
 - i. Comprise solvent weld jointed PVC pipe and heavy duty PVC pipe fittings that conform to the requirements of Table 4.10 (as per the requirements for pipelines with cover depths exceeding 7m).
 - ii. Be adequately supported using support brackets or hangers, with supports designed to take the load of the pipe and its contents, including in a surcharge event, such that the required grade is always maintained. Placement and design of brackets should consider the risk of injury to building users.
 - iii. Be protected from vehicle impact using bollards or guardrails
 - iv. Not be installed in locations where they will be exposed to direct sunlight or sources of heat
 - v. Be designed considering the temperature variation and related thermal expansion and contraction which the pipe may experience due to its installation location
 - vi. Be labelled with marker stickers complying with the requirements of AS 1345 and AS 2700. Markers shall be placed at wall penetrations and at least every 8 m along the pipeline, be coloured black for wastewater, include arrows to indicate flow direction and the words “Water Corporation Sewer” with white uppercase letters at least 28 mm high.
 - j. Property connections to sewers within basements shall not be permissible. The property connection shall be made beyond the building perimeter or at the nearest access chamber. Plumbing fixtures within the basement shall be connected to the sewer via a pumped system that discharges to an access chamber, in accordance with the AS/NZS 3500.2, to prevent overflow to the basement during surcharge or overflow events.
 - k. Pipes installed through basement walls shall be protected at wall penetrations as follows:
 - i. To protect against short and long term settlement of the building, adequate annular space shall be provided around the pipe, and articulated pipe joints may be used if required by the building owner or designer.
 - ii. To prevent water ingress, the pipe shall be provided with a mechanical EPDM seal.
 - iii. A wall penetration detail shall be provided by the proponent as part of the sewer design drawings.

- l. Sewer bypass arrangements to be used during the construction phase shall be considered as part of the design. Bypass pipework shall be constructed and tested in accordance with the requirements of this standard.

4.4 Property Sewer Levels

- a. The design level of the property connection for lots shall satisfy the following conditions:
 - i. The total area of a lot shall be capable of being served with the exclusion of any boundary setback distances required by the Local Authority.
 - ii. At the design point for the commencement of a property sewer a depth to invert of 0.6m shall be provided.
 - iii. Connection levels shall be calculated using distances measured along the boundaries of the lots (not diagonally across lots).
 - iv. The maximum design depth to invert of a property sewer shall be 2.5m.
 - v. Lots less than 1000m² shall be capable of being served at a grade of 1:60.
 - vi. If the lot is 1000m² or larger it is preferred to serve the entire lot at a grade of 1:60. If it can be demonstrated to the Water Corporation's satisfaction that it is not practicable to provide a service to satisfy the above requirements the designer shall consider other options such as:
 - Provision of additional connection points.
 - Servicing a reduced area of the lot.
 - Alternative plumbing options if no other option is available.

In all cases the designer shall ensure that the property connection level is capable of providing a service to the property that complies with AS/NZS 3500.

- vii. Fill may be placed on any site to satisfy the requirements.
 - viii. Where a partial service is provided this shall be indicated on the Design Drawings.
 - ix. In developed areas, if only one or two lots smaller than 1000m² holds down a length of sewer in excess of 400m the above alternative options may be considered.
 - x. Any lots served with property sewers designed using the above constraints shall be marked as "TIGHT CONNECTION" on the Reticulation Plans.
 - xi. Existing developments on lots being sewerred shall be capable of being served.
 - xii. If the requirements for the design level of a property connection cannot be complied with and other options are being considered, advice shall be sought from the Water Corporation.
- b. If contours are derived from an aerial survey the depth to invert should be increased by at least 0.3m unless the contours have been confirmed by checking against ground control.

4.5 Junctions and Property Connections

- a. Junctions shall be provided on the sewer to serve properties as follows:
 - i. For a single residential lot provide one DN100 junction.
 - ii. For a duplex lot provide one DN100 junction for each residential unit.
 - iii. For other lots provide one junction of DN150 minimum.
- b. Junctions at the rear of lots should be on the downstream side of the lots and 1.0m from the side boundary, except where the downstream depth to invert will be greater than the upstream or it would

- be more inconvenient to the householder, especially where rising shaft property connections are required.
- c. Junctions at the front of lots should be on the downstream side of the lots and 7.0m from either side boundary where the sewer passes the property (or located clear of driveways).
 - d. Junctions should be a minimum of 2.0m apart measured centre to centre except on the end of an IO or IS sewer.
 - e. Property connections shall be a maximum of 6.5m in length measured from the sewer to the boundary of the property to be serviced.
 - f. Where a sewer is on an alignment in excess of 4.2m and it is possible to serve the lot from an Access Chamber the junction shall be left on a short IO sewer from the Access Chamber.
 - g. Property connections within 150m of a discharge Access Chamber shall be provided with a boundary trap unless the sewer is protected by a running trap. This applies to all property connections, including those on branch sewers, for all pressure main discharges. Note: a P9 connection shall not be used when a boundary trap is required.
 - h. Where a DN225 sewer carries a pumped flow or will ultimately carry a pumped flow, property connections to the sewer shall be provided with a boundary trap.
 - i. The depth to invert of a property connection shall be generally limited to a maximum of 3.5m. It is preferable to grade connections that are marginally deeper than 3.5m to avoid the use of type P8 double rising shaft.

For sewer depths between 3.5m and up to 5.0m, the Design Engineer shall consider site specific factors such as:

- i. Site/ground conditions e.g. ground water levels, soil types, etc.
- ii. Size of receiving sewer
- iii. Fittings/fixtures required i.e. BTs or RTs
- iv. Construction methodologies/constraints
- v. Timing of construction of the sewers and property connections

and propose the most appropriate solution for property connections; which may be connection to the deep sewer, direct connection to an Access Chamber or Maintenance Shaft, or connection to a shallower parallel sewer. The capital cost of construction as well as the cost and ease of future maintenance and repair should both be considered when assessing options for these property connections.

For sewer depths greater than 5.0m, the Design Engineer shall make allowance for the junctions to be provided off a shallower parallel sewer or an access chamber.

- j. Where a sewer located outside the served property is more than 3.5m deep and the lot can be served from an Access Chamber or Maintenance Shaft the junction shall be left on a short IO sewer with a drop at the Access Chamber or Maintenance Shaft.
- k. Junctions should not be placed in concrete encased sewers but where this is unavoidable both junctions and property connections shall be concrete encased.
- l. Drop junctions shall only be used on property connections where it is impracticable to grade the property connection down to the reticulation sewer and then only with Water Corporation approval.
- m. Property connections shall not be provided to sewers DN450 and larger. The number of property connections to DN300 and DN375 sewers shall be kept to a minimum and a boundary trap shall be provided on each connection. The provision of a shallower sewer shall be considered by the Design Engineer to minimise the number of property connections to DN300 and DN375 sewers.
- n. Where boundary traps are required on property connections they shall be installed with the sewer.

- o. Where a sewered lot is subdivided and a multiple unit residential lot is created, up to five units can be connected to an existing DN100 property connection provided that the development does not require a DN150 property connection in accordance with AS 3500.
- p. The location of property connections shall be indicated by a capped DN40 PN 6 PVC pipe brought to the surface and wrapped with at least two turns of standard sewer tape.
- q. Where a sewer is located outside the served property, the property connections should be terminated within 0.5m from the property boundaries. The Design Engineer shall consult with the Water Corporation prior to terminate any property connections further than 0.5m from the property boundaries including property connections crossing under a retaining wall.
- r. All property connections shall be brought up to within 1.0m of the ground surface level.
- s. The maximum length of property connection permitted in private property adjacent to the property being served shall not exceed 1.8m without prior Water Corporation approval.

4.6 Location of Sewers in Road Reserves, Pedestrian Access Ways and Right of Ways

4.6.1 Sewers Located in Road Reserves

- a. All sewers constructed in the road reserve should be located in accordance with the requirements of the Utility Providers Code of Practice for Western Australia.
- b. Sewers should be constructed on the 3.5m alignment.
- c. If the 3.5m alignment is not available, other alignments may be used within the space 3.0 m to 4.2m. Where possible the sewers should be contained within the 3.0m to 4.2m corridor.
- d. The sewer should be constructed in the verge and the centreline should be a minimum of 1.2 m behind the existing or proposed kerb line.
- e. Where sewers are to be positioned within the 3.0m to 4.2m alignments on both sides of a road reserve, agreement from the telephone service authority shall be obtained.
- f. Other alignments may be used, after written agreement has been obtained from the relevant authorities whose alignments will be utilised.
- g. Where the road reserve boundary is curved or consists of a series of chords and the sewer alignment does not follow the chords the following conditions shall apply:
 - vi. Access Chambers and Maintenance Shafts shall be positioned within the 3.0m to 4.2m alignment.
 - vii. Access Chamber and Maintenance Shaft covers should be behind and clear of the kerb.
 - viii. The minimum distance from the sewer to the property boundary shall be 1.0m.
 - ix. The minimum cover to the sewer shall be 1.5m.
- h. Sewer alignments should not follow road truncations if additional access chambers are required.
- i. Sewers DN375 and larger shall be considered as Trunk Services as defined in the Utility Providers Code of Practice and may be constructed within the Trunk Services alignment by agreement with the relevant authorities.
- j. Sewers shall not be constructed within the reserves of controlled access roads unless the written agreement of the controlling authority has been obtained.

4.6.2 Sewers Located in Pedestrian Access Ways

Because of the increasing tendency for Pedestrian Access Ways to be closed and absorbed into adjacent property, sewers located in PAWs shall comply with the requirements of sewers located in private property. Access Points should not be located on the projected line of a boundary.

4.6.3 Sewers Located in Right of Ways

Sewers along Right of Ways should be located on an alignment of 1.0m from the centre line of the ROW. Access Points should not be located on the projected line of a boundary.

4.7 Requirements for Easements

- a. Easements shall be provided about all sewers constructed in private property as part of a subdivision for a developer. This includes connecting sewers to the subdivision.
- b. An easement should be provided where a sewer is constructed through land already controlled by a government department or an authority other than the Water Corporation. If an easement cannot be obtained, formal written approval for the construction of the sewer shall be obtained from the department or the authority concerned.
- c. Where an easement is required on a property because of a sewer, the easement shall encompass the effects on that property from all sewers.
- d. Where the zone of influence of an easement provided about a sewer extends to an adjacent property which is part of the subdivision, an easement shall be provided on the adjacent property.
- e. The width of an easement shall be uniform on any portion of a sewer between lot boundaries and shall be calculated as follows, based on the average of the greatest and least depths to invert between the boundaries.
 - i. For DN150 and DN225 PVC sewers:
 - For depths of less than 3.0m the width of easements shall be 3.0m.
 - For depths between 3.0m and 5.0m inclusive the width shall be 5.0m.
 - For depths over 5.0m the width shall be twice the depth minus 5.0m.
 - Where a sewer is concrete encased the maximum width of easement required is 3.0m.
 - ii. For all other sewers:
 - For depths of less than 2.0m the width of easements shall be twice the depth plus 1.0m with a minimum width of 3.0m.
 - For depths between 2.0m and 5.0m inclusive the width shall be 5.0m.
 - For depths over 5.0m the width shall be twice the depth minus 5.0m.
- f. Easements shall be located centrally about the centre line of the sewer unless otherwise approved by the Water Corporation.
- g. Easements provided for sewers located in private property on land which forms part of a subdivision undertaken for a developer, shall be “Automatic Easements” created under Section 167 of the Planning and Development Act 2005. Easements required on other land shall be “Deed of Grant Easements”.
- h. Easements are not generally required for sewers constructed on standard alignments in private property for the Water Corporation’s Infill sewerage program projects.

4.8 Crossings of Controlled Access Roads, Roads, Railways and Other Services

4.8.1 General

- a. The number of sewer crossings under freeways, controlled access roads and railways should be kept to a minimum.
- b. Sewers should be located so that crossings under all roads and railways are approximately at right angles to the road and railway reserve boundary.
- c. Where it is proposed to construct sewers crossing under freeways and controlled access roads the following conditions shall be complied with:
 - i. Written approval for the crossing shall be obtained from the controlling authority.
 - ii. Sewers within the road reserve shall be adequately protected.
 - iii. If it is necessary to locate Access Chambers or Maintenance Shafts in the road reserve they shall be placed as close as possible to the reserve boundary.
 - iv. Access to Access Chambers or Maintenance Shafts within the road reserve should be available from outside the reserve.
 - v. Access Chambers and Maintenance Shafts in road embankments shall have the cover graded to the slope of the embankment.
- d. Where it is proposed to construct sewers crossing under railway reserves they shall be constructed to comply with the requirements of the AS 4799 for the Installation of Services and Pipelines within Railway Boundaries. Liaison with the appropriate Rail Authority is necessary at all stages.
- e. A minimum clearance of 150 mm should be maintained between sewers and all other services at crossing points.

4.8.2 Trenchless Construction of Gravity Sewers

4.8.2.1 General

This section generally refers to gravity sewers installed using trenchless techniques. It does not exclude the use of open trenched installation where appropriate.

A full geotechnical investigation is required in the design phase.

There are three arrangements for trenchless installation applications in terms of encasement and grouting requirements:

- a. No encasement pipe (carrier pipe only);
- b. Encasement pipe with an un-grouted annulus;
- c. Encasement pipe with a fully grouted annulus.

The Design Engineer shall determine, with reference to Table 4.9:

- a. Which encasement and grouting arrangement is to be used;
- b. The minimum specification requirements including pipe material, size, pipe class/pipe stiffness, maximum and minimum depth of cover to the top of the carrier pipe and encasement pipe if used, for the installation. The Contractor may increase the pipe stiffness classification and/or cover to suit the installation technique and equipment used.
- c. The installation techniques required or excluded.

Any proposed trenchless techniques by the Contractor together with methodology and an installation plan shall be submitted to and approved by the Water Corporation prior to the commencement of construction.

Refer to example drawing LJ01-4-2 for guidance on how the basic information required for trenchless crossings is to be presented.

4.8.2.2 No Encasement Pipe Installations (carrier pipe only)

This arrangement shall be the first preference. Only approved jacking pipe shall be used and the carrier pipe and joints shall be fully corrosion protected.

The carrier pipeline and associated short and long term side support shall be designed to carry all imposed loads as per the requirements of AS 2566.1.

4.8.2.3 Encasement Pipe with an Un-grouted Annulus

This arrangement shall only apply if there is a specific requirement by the Water Corporation and/or the road/rail controlling authority for having an un-grouted encasement pipe.

For this arrangement:

- A permanent un-grouted encasement pipe (i.e. the life of the encasement pipe including any joints shall exceed that of the carrier pipe) shall be provided. Only approved jacking PVC, reinforced concrete and GRP pipes listed on the Strategic Products Register shall be used.
- All pipe supports within the encasement pipe shall be manufactured from non-corrosive material.
- The ends of the un-grouted encasement pipe shall be sealed with suitable seal material/method to prevent movement of material into the encasement pipe. Seal material shall be selected to allow easy removal of the sewer pipe in case of a failure of the carrier pipe within the encasement pipe and avoid excessive pressure build-up within the encasement pipe causing subsequent failure of the encasement pipe and other nearby infrastructure.
- The encasement pipe shall be designed to carry all imposed loads as per the requirements of AS 2566.1.
- The encasement pipe shall generally provide a minimum annulus dimension between the encasement and carrier pipes of 150mm to make allowance for the deviation in the encasement pipe and the thickenings at the joints of the carrier pipe or any future repair/replacement of the carrier pipe.

For small pipelines and/or minor crossings, a smaller annulus may be acceptable if the designer/contractor can demonstrate that the pipe can be feasibly installed and prior approval is granted by the Water Corporation.

- The sewer (i.e. carrier pipe) can be located anywhere within the encasement pipe provided it is held by supports at the correct level and grade. Normal tolerances shall apply to the sewer.

The carrier pipe joints shall be capable of transferring axial loads, i.e. pipe joints shall remain intact, enabling the pipeline to be installed or withdrawn. The carrier pipe and joints shall be fully corrosion protected.

Notes:

- Non-permanent encasement pipes (i.e. steel pipes) will eventually corrode (particularly at the joints) and allow the surrounding soil to fill the annular gap between the encasement and the carrier pipe, resulting in possible sinkholes. Therefore, steel as an encasement pipe is not considered to have a life exceeding normal carrier pipes.
- Polyethylene shall not be used as an encasement pipe either grouted or un-grouted.

4.8.2.4 Encasement Pipe with a Fully Grouted Annulus

This arrangement shall only apply when the above arrangements do not apply and it helps reduce the impact of open excavation such as dewatering, cost, other nearby infrastructure both during construction and while in service.

For this arrangement:

- Steel and approved PVC, GRP or reinforced concrete jacking pipes listed on the Strategic Products Register are acceptable encasement pipes.
- The encasement pipe shall be designed to carry all imposed loads prior to grouting of the annulus as per the requirements of AS 2566.1.
- The encasement pipe shall generally provide a minimum annulus dimension between the encasement and carrier pipes of 150mm to make allowance for the deviation in the encasement pipe and the thickenings at the joints of the carrier pipe. It also shall provide sufficient space for grouting.

For small pipelines and/or minor crossings, a smaller annulus may be acceptable if the designer/contractor can demonstrate that the pipe can be feasibly installed and prior approval is granted by the Water Corporation.

- The sewer (i.e. carrier pipe) can be located anywhere within the encasement pipe provided it is held by supports at the correct level and grade. Normal tolerances shall apply to the sewer.
- Grouting pressures are to be selected and controlled to avoid collapse of the carrier pipe.
- Spacers/supports shall be used to prevent flotation/displacement of the carrier pipe during grouting.

4.8.2.5 Installation Requirements

The Design Engineer shall specify the minimum installation requirements. Table 4.9 provides guidelines for minimum requirements for trenchless installations.

4.8.2.6 Major Road Crossings

For major road crossings the encasement pipe shall as a minimum extend the full width of the road reserve plus 1500mm.

4.8.2.7 Rail crossings

Rail crossings shall comply with AS 4799 and the rail owner's requirements.

No metallic encasement pipe shall be used under electrified railway systems to prevent stray-current corrosion.

Crossings under railway turnouts and level crossings shall be avoided.

4.9 Cover to Sewers

- a. The minimum cover to sewers in road reserves and trafficable ROW's shall be 0.9m. Where a sewer in a road reserve will be parallel to the road pavement, the top of the sewer shall be at least 0.75m lower than the crown of the road or the ground level at the centre of the road reserve.
- b. The minimum cover to sewers elsewhere shall be 0.75m.
- c. In special cases the minimum cover may be varied with the approval of the Water Corporation but particular conditions may apply.
- d. The above requirements for cover to sewers shall be increased by 0.3m in the following circumstances:
 - i. Sewers being designed from contours derived from aerial surveys where the contours have not been confirmed by checking against ground control.
 - ii. Sewers being designed in road reserves when road design levels are not available.

- e. Fill may be placed on any site to satisfy the above requirements.

4.10 Access Chambers and Maintenance Shafts

4.10.1 General

- a. All sewer systems shall be designed on the basis that Access Chambers will be located in accordance with the requirements of Clause 4.10.2.
- b. Consideration should be given to using Maintenance Shafts in lieu of access chambers on DN150 and DN225 sewers, in accordance with the requirements of Clause 4.10.3, in all Regions except the North West Region. Maintenance Shafts require special equipment for inspection and cleaning, this equipment is not readily available in the North West Region.
- c. All access chambers and maintenance shafts shall be numbered. Numbers shall be provided by the Water Corporation after the initial submission. Access chambers and maintenance shafts are numbered in an ascending order from the downstream end of the sewer network. Access chambers constructed in conjunction with an overflow system at a pumping station are also to be numbered.

4.10.2 Access Chambers

- a. The maximum allowable distances between Access Chambers are shown in Table 4.4.
- b. Access Chambers shall be provided at the following locations:
 - i. At a change of grade.
 - ii. At a change of direction.
 - iii. At a change of pipe diameter.
 - iv. At a change of pipe pressure or stiffness classification.
 - v. At sewer intersections other than those with an IS sewer.
 - vi. At the end of a pressure main (unless a maintenance shaft can be used).
- c. Not more than one Access Chamber should be located in any one lot.
- d. Where possible the top of covers of Access Chambers constructed in unpaved areas subject to flooding, should be raised to at least 100mm above the estimated maximum flood level. In such circumstances filling shall be placed to provide a clear and level compacted area of one metre all around the Access Chamber at a level of 50mm below the top of the cover.

Where there is a likelihood of sewers becoming operational (carrying sewerage flows) requiring maintenance prior to the subdivision becoming fully developed with permanent access provided to the sewer access chambers, temporary access shall be provided.

Generally, a gravel or limestone track is adequate. Input from the relevant Water Corporation's operation staff on details and extent of access shall be discussed and agreed upfront during the design phase and clearly shown on the relevant reticulation drawings.

In undeveloped areas, a clear and level compacted area of one metre all around the access chambers shall be provided to allow for the safe erecting of safety equipment such as tripods and safe removal of access chamber covers. When not in future road pavement, approved solid top covers shall be used in preference to concrete infill covers.

- e. In drop Access Chambers, the minimum difference in invert levels between the invert of the drop and the invert of the outlet sewer shall be as shown in Table 4.5. The differences are based on connecting the tumbling bay junction directly to the bend. Small drops through Access Chambers are not allowed where it is possible to grade the invert of the inlet sewer to the invert of the outlet sewer.

- f. If a DN300 drop is constructed on an Access Chamber the drop shall be opposite to the Access Chamber outlet unless a form of energy dissipation is provided
- g. Drops should be external to Access Chambers but internal drops may be used to connect DN150 sewers to existing Access Chambers with prior approval of the Water Corporation. All the following conditions for internal drops shall be complied with:-
 - i. An external drop would be difficult to construct.
 - ii. Space within the access chamber shall not be unduly restricted.
 - iii. The drop shall be constructed in PVC.
 - iv. Only one drop shall be constructed within any one Access Chamber.
- h. Materials required for the construction of Access Chambers in various locations are shown in Table 4.6. A particular material shall only be used where “YES” is indicated beside all the relevant “Access Chamber Location or Type” criteria shown in the table. Where a pressure main discharge is to be added to an existing system, the downstream network shall be assessed, including requirements for access chamber materials.
- i. Requirements for Access Chamber covers are shown in Table 4.7.
- j. Special treatment of cast iron and ductile iron Access Chamber covers in areas with special paving finished shall be limited to filling the cells in the covers and frame with coloured concrete or textured material.
- k. Access Chambers in Primary District (A), District (B) and Distributor roads as defined in the Main Roads Western Australia publication “Metropolitan Functional Road Hierarchy”, require bolt down covers and shall be shown on reticulation plans as BD under the access chamber symbol.
- l. The minimum clearance between any two sewers entering an Access Chamber shall be 100 mm at the internal face of the access chamber wall.
- m. At Access Chambers on DN150 and DN225 sewers, if the included angle between any upstream sewer and the downstream sewer is less than 85° (i.e. re-entrant angle) the following conditions shall apply:
 - i. The radius of the centre line of the channel from the inlet to the outlet shall be the maximum practicable and shall be a minimum of 285 mm.
 - ii. The centre lines of the upstream sewer and downstream sewer need not meet at the centre point of the Access Chamber
 - iii. A fall of 0.03m shall be provided in the channel between the upstream and downstream sewers.
 - iv. The minimum clearance between the internal faces of the Access Chamber wall measured along the extension of the centre line of the upstream sewer shall be 800 mm.
 - v. A detailed drawing to a minimum scale of 1:50 shall be provided to show the offset of the sewers, the arrangement of the channels within the Access Chamber and the relationship of the Access Chamber cover to the property boundary.
- n. For sewers DN300 and larger, the minimum angle between the upstream sewer and the downstream sewer at an Access Chamber shall be 90°.
- o. Where inlets left on existing Access Chambers on DN150 and DN225 sewers are to be extended, a bend of up to 15° can be placed on the inlet to correct the horizontal or vertical direction of the proposed sewer extension. If the correction is in excess of 15° the inlet shall be replaced. Where a bend is used the bend shall be located within 200mm of the outside of the wall of the Access Chamber.
- p. Access Chambers are not allowed in lots with a zoning R30 or greater.
- q. When Access Chambers are temporarily, or permanently, located in fields, bush reserves or more generally in undeveloped areas where they could potentially be obstructed or damaged, a marker post

labelled “Access Chamber” shall be installed within 300mm of any edge of the concrete surrounds and shall be as detailed on the Standard Drawing KA76-1-1.

r. Structural and Buoyancy Balance Requirements:

Precast Access Chamber components shall be in accordance with SPS 700 and shall, for acceptance, be subject to authorisation by the Corporation.

Structures for water retaining applications including access chamber assemblies shall be analysed and designed for a typical range of buried applications, depths and ultimate limit state load action combinations in accordance with AS 1170, with particular reference to AS 1170.0 Sub-clause 4.2.

The design basis shall provide for installation of access chamber assemblies in a wide range of typical WA locations and shall be sufficiently robust to obviate the need for multiple project-specific geotechnical or buoyancy balance analyses at individual project locations. The following installation, geotechnical and site risk mitigation constraints shall accordingly apply:

- i. The self-weight of an access chamber assembly shall, for the purposes of buoyancy balance calculations and design, exclude the weight of removable/replaceable access cover, frame and concrete surround assemblies, make-up brickwork (or concrete spacers/make-up rings) above conversion slab height. It shall also exclude the weight of planned chamber internal fixtures, equipment and fluids. An access chamber or pit shall be considered empty for the purposes of buoyancy balance analysis.
- ii. The self-weight of conversion slab and integral precast base section benching concrete, duly supported by dimensioned conversion slab and base product drawings, may be included for the purpose of buoyancy balance calculations.
- iii. The contribution of soil mass other than that vertically above access chamber projections to down-thrust forces shall be limited to a vertical soil cone whose outer surface deviates from the vertical by an angle not exceeding 3° and whose lower horizontal surface does not extend beyond the structural access chamber projections;
NOTE: The specific gravity value of soil surround (given in AS/NZS 2566) should be 2.65 except where supported by individual project-specific sampling, testing and certification that validate a different value.
- iv. Buoyancy calculations shall be on the basis of a ground water level at or higher than the finished surface level at a typical access chamber installation site. The ground water level shall generally be assumed to be at the finished surface level.
- v. The self-weight of submerged soil shall, for the purposes of down-thrust force analysis, be reduced by its own buoyancy. Buoyancy balance calculations shall provide for an effective submerged soil density not exceeding 10kN/m^3 , in the absence of otherwise evidence, supported by certified site-specific soil test data, that is acceptable to the Corporation

For acceptance, the aggregated down-thrust force due to the self-weight of chamber structure and soil body, duly factored by 0.9, shall exceed or equal the aggregated buoyant up-thrust force, duly factored by 1.2, subject to the constraints defined in (i) to (v) above.

Where a different or lower groundwater level is considered for the purpose of buoyancy calculations, the level shall be based on validated long term groundwater data records and a buoyancy up-thrust force, equal to 1.5 times the calculated value, shall be applied to chamber buoyancy balance analysis, in accordance with the requirements of AS/NZS 1170.0 Sub-clause 4.2.

4.10.3 Maintenance Shafts

- a. General
 - i. Maintenance Shafts are designed to permit most routine sewer inspections and maintenance functions to be carried out from ground level.
 - ii. Only Maintenance Shafts approved by the Water Corporation shall be used.
- b. Typical configurations of Maintenance Shafts are:
 - i. Angled up to and including 90° to 270°.
 - ii. Straight through (180°).
 - iii. Straight through with additional inlets at 90°, 270° or both.

Using standard angled Maintenance Shafts with factory formed bends of up to 15° fitted onto the upstream inlets, all angles between 75° and 285° can be achieved. Minimum and maximum angles possible are dependent on the brand of maintenance shaft used. This information is available from the manufacturer based on approvals given by The Water Corporation.

- c. Maintenance Shafts can be used on DN150 to DN375 sewers in lieu of Access Chambers in public land, verges, paved areas and private property in accordance with the following requirements:
 - i. Where the horizontal and vertical deviation between the upstream and downstream sewers at an Access Point can be achieved using a standard Maintenance Shaft or a standard Maintenance Shaft and a bend of up to 15° placed on the upstream inlets of the shaft.
 - ii. Where flow to flow conditions can be applied.
- d. Three consecutive Maintenance Shafts can be used on DN150 or DN225 sewers, provided the distance between Access Chambers is not greater than 400m. Where this may result in an Access Chamber in a lot zoned >R30 then the matter should be raised with the Water Corporation to see if a variance can be arranged.
- e. A maximum of two consecutive DN375 or DN300 Maintenance Shafts can be used at a maximum distance of 150m. Only maintenance shafts which have been approved for this purpose shall be used.
- f. Only where space considerations are at a premium may a maintenance shaft be the drop point. Maintenance Shafts can incorporate two higher level branch sewers discharging into the riser shaft.
 - i. On Maintenance Shafts where a drop is used the minimum difference in invert levels between the invert of the drop and the invert of the Maintenance Shaft shall be 0.7m. Where two drops are used the minimum difference in invert levels between the drops shall be 0.56m. Bends shall not be used on drop inlets.
 - ii. Drops in maintenance shafts present difficulties in rodding and jetting access, and in such cases it is strongly preferred that the maintenance shaft and the access chamber be swapped around so that the drop occurs at the access chamber.
 - iii. If a drop is used, an access chamber shall be used upstream of the drop on a continuous sewer or an inspection shaft on an IO sewer.
 - iv. Grading out the drop or replacing the maintenance shaft with an access chamber is preferred.
- g. Where Maintenance Shafts are being used, consideration should be given to locating Access Chambers in public land where possible, to simplify operational requirements.
- h. Where Maintenance Shafts are being used, consideration should be given to locating Access chambers at sewer intersections where possible (where the Access Point consists of two incoming sewers and an outgoing sewer).
 - i. IO sewers are permitted off Maintenance Shafts.
 - j. Where an IS sewer is constructed off a Maintenance Shaft IO sewer, the connection point of the IS sewer to the IO sewer shall be in public land if the IS sewer is longer than 7.0 m.

- k. The depth of a Maintenance Shaft shall not exceed 4.0m from the top of the cover to the invert level of the Maintenance Shaft unless approved by the Water Corporation.
- l. Maintenance Shafts can be used at pressure main discharges for DN100 and DN150 pressure mains only.
- m. Subject to confined space requirements Maintenance Shafts may be used to connect into existing sewers.
- n. Maintenance Shafts shall not be used at the first Access Point upstream of DN300 or larger sewers (because of running trap requirements).
- o. Maintenance Shafts shall not be used where pipeline gradients and pipeline depths will result in the riser shaft having a deviation from the vertical in excess of 0.3m (i.e. projected centreline of base to centreline at surface).
- p. Where a Maintenance Shaft is used in lieu of an Access Chamber the design shall be adjusted to remove the 0.01m fall across the Access Point.
- q. Maintenance shafts shall be provided with PVC screwed caps on the shaft.
- r. Where a new sewer is to be connected to an existing maintenance shaft and no inlet exists, the maintenance shaft shall be replaced.

4.10.4 Deleted Access Chambers

Deleted access chambers are no longer incorporated in sewer designs for the Water Corporation however, the provisions for deleted access chambers still exist in the sewer system.

Details of deleted access chambers are shown on drawing AA01-90-1 for reference.

4.11 Interconnection of Sewers Other Than Property Sewers

- a. The number of reticulation sewer connections to Main Sewers shall be kept to a minimum.
- b. Where sewers are connected to sewers with a diameter up to and including DN375, flow to flow conditions shall be complied with. The depths of flow to be used shall be:
 - c. Half full for DN150 pipes
 - d. Two thirds full for DN225 and larger pipes.
- e. Falls shall be provided through access chambers as shown in Table 4.8 and in Figures 4.1 to 4.4. Falls are not required through maintenance shafts.
- f. Where DN150 and DN225 sewers are connected to DN300 and DN375 sewers the following requirements apply:
 - i. The DN150 and DN225 connecting sewers shall have a running trap installed immediately downstream of the last Access Chamber before the DN300 or DN375 sewer.
 - ii. Property connections downstream of the running trap shall be provided with a boundary trap.
 - iii. Property connections on IO and IS sewers connected to DN300 or DN375 sewers shall be provided with boundary traps
- g. Where DN150 and DN225 sewers are connected to sewers DN450 and larger the following requirements apply:
 - iv. Connections shall be constructed as shown in Figures 4.1 and 4.2.
 - v. Property sewers shall not be connected to the last section of connecting sewer before the Main Sewer.
 - vi. DN150 and DN225 connecting sewers shall have a running trap installed immediately downstream of the last Access Chamber before the Main Sewer.

- h. Where it is proposed to connect a drop to an existing Access Chamber on a Main Sewer the structure shall be external to the Access Chamber unless approved by the Water Corporation and a drawing shall be provided detailing the work required.
- i. Where DN300 to DN600 sewers are connected to sewers DN450 and larger the following requirements apply:
 - vii. Connections shall be constructed as shown in Figure 4.3 but if the difference in diameter between the upstream and the downstream sewers is 200mm or less they shall be connected flow to flow
- j. A summary of the required falls through Access Chambers, other than drop access chambers and maintenance shafts, is shown in Table 4.8

4.12 Pipes, Pipe Fittings and Joint Seals

4.12.1 Pipeline Selection Guidelines

Extensive information and guidance on conveyance pipeline system characteristics, selection criteria, interconnectibility, usage constraints and risk considerations has been published in the Pipeline Selection Guidelines. These guidelines are intended for application by pipeline designers and specifiers to select pipeline system components that are best for Water Corporation business, in terms of pipeline material, configuration, service, constructability, operability, maintainability and longevity performance.

The primary intent of the Pipeline Selection Guidelines is the planning and establishment by pipeline designers, at an early stage, of pipeline baseline requirements on the basis of fitness for project applications, in terms of longevity design and installation quality for hand over to the pipeline owner.

4.12.2 Requirements and Limitations

- a. For acceptance, pipes, pipe fittings and pipe joint seals shall be new and unused. They not have been exposed to physical or structural (fracturing, chipping, scratching or similar) damage nor to prolonged outdoor environments including elevated temperatures and UV radiation. Suppliers shall provide due evidence of conformity with these requirements throughout supply related product storage, transportation and handling operations, if and as required.
- b. In particular, PVC pipes and fittings shall have been manufactured no earlier than 12 months prior to supply. The use of PVC pipe, with a manufacturing date older than 12 months prior to pipeline installation, may be considered by the Water Corporation on a project-by-project basis, subject to the acceptability of documentary evidence that verifies pipe and fittings protection from exposure to sunlight and elevated temperatures since their manufacture.
- c. The Water Corporation has authorised a range of pipeline products produced by particular pipes and pipe fittings manufacturers for use in Water Corporation assets. A listing of these is published from time to time in the Strategic Products Register. Only authorised pipes and pipe fittings shall be used, as indicated in the following clauses.
- d. Interconnection of PVC sewer pipe with older vintage AC and VC sewer (non-pressure) pipes shall generally be by means of an intervening access chamber. Direct pipe to pipe inter-connection may be considered as an alternative, subject to the conditional use of pipe couplings or purpose designed adaptors acceptable to (and authorised by) the Water Corporation, as follows:
 - 316 stainless steel barrelled gibault style ‘multifit’ couplings that are dimensionally compatible with both mating pipe outside diameters;
 - Flexible elastomeric socketed adaptor couplings with stainless steel clamping bands that are dimensionally compatible with both mating pipe outside diameters;
 - DWV PVC (or GRP) spigot to socket adaptor couplings that have been purpose designed for direct inter-connection with VC pipe.

- e. The pipe to pipe joint fittings shall be used at the point of conversion and concrete encased for a distance of at least 150mm beyond the connector/adaptor fittings.
- f. Embedment and trench fill of pipelines buried in open trench excavations shall comply with the requirements of Clause 5.2.6.
- g. Buried flexible pipelines shall be designed in accordance with the requirements of AS/NZS 2566.1 and the pipe manufacturer's recommendations, to suit site and environmental conditions. The allowable depths of cover to the top of the pipes given in the following sections are indicative values only that have been based on an embedment soil modulus of 7MPa when construction is carried out as per the requirements of Clause 5.2.6 and with a native soil modulus of 5MPa.
- h. The Design Engineer shall undertake the necessary site investigations to establish the actual pipeline site and environmental conditions, pipeline trench and embedment characteristics. The Design Engineer shall determine and specify appropriate design and installation requirements, based on investigation data and engineering calculations.

4.12.3 PVC Pipes and Fittings

For acceptance, PVC pipes and fittings shall be subject to the manufacturing age requirements set out under the foregoing Sub-clause 4.12.2 "Requirements and Limitations".

- a. PVC pipes shall be generally used in all residential, commercial and industrial areas for sewer sizes up to and including DN375.
- b. PVC pressure pipes may be used for DN450 sewers where authorised by the Water Corporation.
- c. PVC profile wall pipes and fittings may be used for DN375 sewers where authorised by the Water Corporation.
- d. Injection moulded PVC pipe fittings shall be used in preference to fabricated or wrap-reinforced fittings wherever available and duly authorised by the Corporation. The use of fabricated and wrap-reinforced PVC pipe fittings shall be subject to the acceptability of structural strength/stiffness test performance evidence and subject to embedment or encasement material (e.g. concrete) performance specifications. The use of PVC pipe with higher stiffness (> SN 16) or pressure (> PN 12) ratings may reduce dependence on wrap reinforcing specifications to achieve the required fitting structural strengths.
- e. Pipe and fittings up to and including DN300 shall generally be solvent cement jointed.
- f. DN375 - and DN450 where specifically approved - pipes and fittings shall be elastomeric seal jointed.
- g. PVC-U non-pressure pipes and fittings (DN < 375) shall be in accordance with the requirements of AS/NZS 1260. Where the use of DN 450 PVC pipe has specifically been justified and accepted by the Corporation, it shall be pressure pipe in accordance with the requirements of SPS 115 or SPS 116, with a minimum pressure rating of PN 16 and coloured in accordance with AS/NZS 1260 Clause 2.3.
- h. PVC pipelines shall be installed and field pressure tested in accordance with AS/NZS 2032.
- i. Standard and heavy duty strength PVC pipe and fittings shall be in accordance with the requirements and subjective conditions set out in Table 4.10, as applicable to the cover depths nominated in the table.
- j. Only PVC pipeline components that have been specifically authorised - and listed in the Strategic Products Register - for use in trenchless applications shall be permissible in those applications.
- k. Where a pipe size has been increased to allow for trenchless installation, the pipe shall be laid in accordance with the grades and inverts specified for the (smaller) pipe being replaced. For example, where a DN 225 pipe is to be replaced by a DN 300 pipe, the grades and falls through access chambers in Tables 4.4 and 4.8 for DN 225 pipe shall respectively apply. The use of tapered/reducer pipe fittings at pipeline entries into access chambers shall generally be restricted to circumstances where their use has been justified and agreed by the Corporation. Proposals for altering any aspect of a grade 'flattened' pipe shall be subject to prior written agreement by the Corporation.

4.12.4 Vitrified Clay (VC) Pipes and Fittings

- a. Pipes and fittings shall be Class Z in accordance with AS 1741, with flexible spigot and socket elastomeric seal joints.

4.12.5 Reinforced Concrete Plastic Lined (RCPL) Pipes and Fittings

- a. RCPL pipes may be used for DN600 or larger sewers.
- b. Where a pipeline flow rate is likely to be very low, its plastics lining shall protect the upper 35% of internal pipe circumference, leaving the unlined gap at pipe invert. In all other flow conditions at least the upper 33% of pipe circumference shall be plastics lined.
- c. Pipe joints shall consist of a flexible jointing system using compressible joint rings.
- d. Pipes shall be in accordance with the requirements of AS 4058.
- e. The Design Engineer shall determine an appropriate load class for the pipe to be used, in accordance with AS/NZS 3725.

4.12.6 Ductile Iron (DI) Pipes and Fittings

- a. Commonly available bitumen coated/Portland cement lined DI pipe shall not be used in non-pressure (gravity) wastewater conveyance applications. Proposals for the use of DI pipe shall be subject to prior specific consideration and acceptance by the Water Corporation of the corrosion free longevity likely to result from the pipe lining and coating characteristics (e.g. fused polymeric or zinc/aluminium coatings and sulphate resistant cement lining) offered by the pipe manufacturer.
- b. For consideration of acceptance, DI pipes shall be in accordance with AS/NZS 2280 and shall be coated and lined to an acceptable specification that assures the required pipeline longevity
- c. DI pipe fittings shall be in accordance with SPS 106 including internal and external thermal bond coating in accordance with AS/NZS 4158.

4.12.7 Polyethylene (PE) Pipes and Fittings

- a. PE pipes and fittings shall only be used for specialist requirements for DN450 pipes and larger, subject to project specific consideration and acceptance by the Water Corporation.
- b. Pipes and fittings shall be in accordance with SPS 125, including demonstrated compliance with AS/NZS 4130.
- c. Pipe jointing work shall be in accordance with the pipe manufacturer's recommendations and the requirements of WS 2 and shall be subject to project specific consideration and acceptance by the Water Corporation.

4.12.8 Glass Reinforced Plastic (GRP) Pipes and Fittings

- a. GRP pipes and fittings may be considered for used in DN450 and larger pipelines, subject to project specific consideration and acceptance by the Water Corporation.
- b. GRP pipes and fittings shall be in accordance with SPS 130, including compliance with AS 3571.1.
- c. Pipe handling, jointing and installation shall be in accordance with the manufacturer's installation recommendations as accepted by the Water Corporation.
- d. Each Pipe shall be supplied with an integral flexible (elastomeric seal) joint socket at one end and a matching machined spigot at the other end.
- e. Where the depth of cover to the top of the pipe for open trench excavation is less than 6.0m, a minimum pressure rating of PN 3 and a minimum stiffness rating of SN 10,000 shall apply;

- f. Where the depth of cover to the top of the pipe exceeds 6.0 m, the Design Engineer shall, in consultation with the pipe manufacturer, undertake design calculations in accordance with AS 2566.1 and shall determine an appropriate pipe stiffness classification.

4.12.9 Elastomeric Joint Seals

- a. Joint rings shall be manufactured from Polychloroprene Rubber (Neoprene) or Styrene-butadiene Rubber and shall conform to the manufacturer's recommendation for the type of pipe being used.
- b. Joint rings shall be manufactured, tested and stored in accordance with the requirements of AS 1646.

4.13 Pipe embedment and trench fill

- a. Embedment and trench fill requirements shall comply with Clause 5.2.6.
- b. Embedment requirements for DN100 to DN375 PVC pipelines are shown on the Standard Drawings.
- c. The embedment requirements for other types of pipe and pipe sizes shall be determined and specified by the Design Engineer, in consultation with the pipe manufacturer.

4.14 Concrete Encasement

- a. Where concrete encasement of a sewer pipe is required, the minimum thickness of concrete around the sewer shall be as follows:
 - i. For cast in situ concrete encasement - 150mm
 - ii. For precast concrete encasement - 100mm \pm 10mm around the pipe barrel, subject to a maximum 3.0m length of precast concrete encased sewer. Gaps between encasement concrete sections at pipe joints shall not exceed 10mm and shall be filled with cement mortar.
 - iii. For precast concrete encasement around pipeline bends - 75mm, measured from the outer surface of bend socket.
- b. Sewers that shall be concrete encased include:
 - iv. Sewer crossings under open drains and creeks where pipe cover is less than the recommended or designed minimum cover;
 - v. Slip and similar repair couplings which create an elastomeric seal joint in an otherwise solvent cement jointed DN150 to DN300 PVC sewer pipeline. Concrete encasement shall extend 150mm beyond coupling ends;
 - vi. Sewer sections and joints where required to reduce abnormal sewer repair/maintenance visits.

TABLE 4.1

WASTEWATER DESIGN FLOWS FROM RESIDENTIAL AREAS SOUTH OF LATITUDE 26° SOUTH RESIDENTIAL PLANNING CODE	NUMBER OF PERSONS PER DWELLING	POP. DENSITY PERSONS/NET ha	DRY GROUND		WET GROUND	
			FLOW L/PERSON/DAY	*G.S.D.F. L/s/NET ha	FLOW L/PERSON/DAY	*G.S.D.F. L/s/NET ha
R15 AND LESS	3.5	52.5	180	0.164	230	0.210
R20	3.5	70	180	0.219	220	0.267
R25	3.5	87.5	180	0.273	210	0.319
R30	3.5	105	180	0.328	205	0.374
R40	3.0	120	180	0.375	200	0.417
R50	3.0	150	180	0.469	200	0.521
R60	3.0	180	180	0.563	195	0.609
R80	2.5	200	180	0.625	195	0.677
R100	2.2	220	180	0.688	190	0.726
R160	2.0	320	180	1.000	190	1.056
R220	1.9	418	180	1.306	190	1.379
R280	1.8	504	180	1.575	190	1.663
R360	1.7	612	180	1.913	190	2.019
R480	1.6	768	180	2.4	190	2.533

*Sewer Design Flow

TABLE 4.2

WASTEWATER DESIGN FLOWS FROM RESIDENTIAL AREAS NORTH OF LATITUDE 26° SOUTH

RESIDENTIAL PLANNING CODE	NUMBER OF PERSONS PER DWELLING	POP. DENSITY PERSONS/NET ha	DRY GROUND		WET GROUND	
			FLOW L/PERSON/DAY	*G.S.D.F. L/s/NET ha	FLOW L/PERSON/DAY	*G.S.D.F. L/s/NET ha
R15 AND LESS	3.5	52.5	230	0.210	280	0.255
R20	3.5	70	230	0.280	270	0.328
R25	3.5	87.5	230	0.349	260	0.395
R30	3.5	105	230	0.419	255	0.465
R40	3.0	120	230	0.479	250	0.521
R50	3.0	150	230	0.599	250	0.651
R60	3.0	180	230	0.719	245	0.766
R80	2.5	200	230	0.799	245	0.851
R100	2.2	220	230	0.879	240	0.917
R160	2.0	320	230	1.278	240	1.333

* Sewer Design Flow

TABLE 4.3

WASTEWATER DESIGN FLOWS FROM OTHER THAN RESIDENTIAL AREAS

SOUTH OF LATITUDE 26° SOUTH

DEVELOPMENT	FLOW LITRES/NET ha/DAY	*G.S.D.F. L/S/net HA	Flow LITRES/net HA/day	*G.S.D.F. L/s/NET ha
	DRY GROUND		WET GROUND	
Suburban Commercial Areas, Schools, Hospitals and Public Purpose land	9,450	0.164	12,075	0.210
Hotels and Motels	21,600	0.375	24,000	0.417
Perth Central Business Area	172,800	3.000	172,800	3.000
Industrial Areas	14,976	0.260	16,992	0.295

NORTH OF LATITUDE 26° SOUTH

DEVELOPMENT	FLOW LITRES/NET ha/DAY	*G.S.D.F. L/S/net HA	Flow LITRES/net HA/day	*G.S.D.F. L/s/NET ha
	DRY GROUND		WET GROUND	
Suburban Commercial Areas, Schools, Hospitals and Public Purpose land	12,075	0.210	14,700	0.255
Hotels and Motels	27,600	0.479	30,000	0.521
Industrial Areas	14,976	0.260	16,992	0.295

*Sewer Design Flow

TABLE 4.4
SEWER GRADES

PIPE DIA. Mm	MINIMUM GRADE	MAXIMUM GRADE	MAXIMUM DISTANCE BETWEEN ACCESS CHAMBERS/ MAINTENANC E SHAFTS	MAXIMUM ALLOWABLE FLOW WITHIN THE RANGE OF GRADES SHOWN BELOW		
				FROM	TO	L/s
150	1:200	1:5 (1)	100m	-	1:100	8
				1:101	1:200	6
				1:201	1:250 (2)	5
225	1:300	1:5 (1)	100m	-	1:200	27
				1:201	1:300	22
				1:301	1:350 (2)	20
300	1:400	1:30	150m	-	1:250	50
				1:251	1:400	40
375	1:450	1:40	150m	-	1:300	85
				1:301	1:450	70
450	1:500	1:55	150m	-	1:350	125
				1:351	1:500	110
600	1:800	1:80	180m	-	1:400	250
				1:401	1:600	200
				1:601	1:800	180

- (1) I.S. sewers may be graded steeper than 1:5 to avoid drop junctions on sewers
- (2) Conditional range of flows – Refer to 4.2.1 n to q.

TABLE 4.5

DROP THROUGH ACCESS CHAMBERS

PIPE DIAMETERS (mm)		MINIMUM DIFFERENCES IN INVERT LEVELS (metres)	
DROP	SEWER	VC PIPEWORK	PVC PIPEWORK
150	150	0.46	0.40
150	225	0.54	0.48
150	300	0.59	0.53
150	375	0.64	0.58
225	225	0.61	0.87
225	300	0.66	0.92
225	375	0.71	0.97

TABLE 4.6
CONSTRUCTION MATERIALS FOR ACCESS CHAMBERS

ACCESS CHAMBER LOCATION OR TYPE	ACCESS CHAMBER MATERIAL		
	PRECAST CONCRETE SEGMENTS WITH WALL THICKNESS <150mm	CONCRETE WITH MINIMUM WALL THICKNESS OF 150mm	PLASTICS LINED CONCRETE
ON DN150 AND DN225 SEWERS	Yes	Yes	Yes
ON DN300 AND LARGER SEWERS	No	No	Yes
PRESSURE MAIN DISCHARGE ACCESS CHAMBER (refer note)	No	No	Yes
WITHIN 150m DOWNSTREAM OF PRESSURE MAIN DISCHARGE	No	Yes	Yes
AT DROP ON SEWER CONVEYING PRESSURE MAIN DISCHARGE	No	No	Yes

NOTE: Private pressure mains (DN50 and DN65) do not normally have to be provided with plastic lined discharge access chambers, however the relevant Regional Manager Assets may require a plastic lined discharge access chamber.

TABLE 4.7

TYPES OF ACCESS CHAMBER AND MAINTENANCE SHAFT COVERS

ACCESS CHAMBERS ON SEWERS DN300 AND LARGER, MAINTENANCE SHAFTS ON SEWERS DN300 AND DN375 AND ON PRESSURE MAIN DISCHARGES			
ACCESS CHAMBER AND MAINTENANCE SHAFT LOCATION	ROAD PAVEMENTS	VERGES, ROAD RESERVE, RESIDENTIAL & NON-RESIDENTIAL DRIVEWAYS, CAR PARKS, TRAFFICABLE RIGHT OF WAYS, WITHIN PROPERTIES IN CLAY GROUND AND GROUND SUBJECT TO FLOODING	ELSEWHERE INCLUDING PRIVATE PROPERTY, PARKS AND RESERVES
TYPE OF COVER	RECTANGULAR CLASS D DUCTILE IRON CONCRETE INFILLED	RECTANGULAR CLASS D DUCTILE IRON SOLID TOP	RECTANGULAR CLASS B DUCTILE IRON SOLID TOP

ACCESS CHAMBERS AND MAINTENANCE SHAFTS ON DN150 AND DN225 SEWERS			
LOCATION	ROAD PAVEMENTS	VERGES, ROAD RESERVE, RESIDENTIAL & NON-RESIDENTIAL, DRIVEWAYS, CAR PARKS, TRAFFICABLE RIGHT OF WAYS, WITHIN PROPERTIES IN CLAY GROUND AND GROUND SUBJECT TO FLOODING	ELSEWHERE INCLUDING PRIVATE PROPERTY, PARKS AND RESERVES
TYPE OF ACCESS CHAMBER COVER	RECTANGULAR CLASS D DUCTILE IRON CONCRETE INFILLED	RECTANGULAR CLASS D DUCTILE SOLID TOP	RECTANGULAR CLASS B DUCTILE IRON SOLID TOP
TYPE OF MAINTENANCE SHAFT COVER	CIRCULAR CLASS D DUCTILE IRON SOLID TOP	CIRCULAR CLASS D DUCTILE IRON SOLID TOP	CLASS B DUCTILE IRON SOLID TOP

NOTES:

1. Access cover and frame assemblies shall be in accordance with SPS 801.
2. Solid Top covers are defined as covers which have not been filled with concrete.
3. Concrete infilled covers are DI covers with concrete-filled recessed tops that are required in vehicular traffic applications, in preference to solid top covers, because of their higher resistance to flexural vertical movement.
4. Only covers and frames authorised by the Water Corporation - as listed in the Strategic Products Register - shall be used.
5. Rectangular covers shall generally mean two-part covers in accordance with SPS 801.
6. On pressure main discharges and access chambers immediately downstream of the discharge point where there is a potential pressure build-up, the Design Engineer shall consider specifying concrete infilled covers or bolt-down solid top covers.

TABLE 4.8
FALLS REQUIRED THROUGH ACCESS CHAMBERS (METRES)
(Falls not required through Maintenance Shafts)

DOWNSTREAM PIPE DIAMETER (mm)	UPSTREAM PIPE DIAMTER (mm)					
	150	225	300	375	450	600
150	0.01					
225	0.09	0.01				
300	0.14	0.06	0.01			
375	0.19	0.11	0.06	0.01		
450	0.06	0.06	0.11	0.06	0.01	
600	0.08	0.08	0.08	0.08	0.11	0.01

Table 4.9: Minimum Requirements for Trenchless Installations

In addition to any requirements of the road or rail owners, the Water Corporation has the following minimum requirements for the trenchless installation applications. The table below lists the general minimum requirements from the Water Corporation regarding the trenchless installations. The installation outside these guidelines will require project specific acceptance.

Input Conditions							
Select the furthest right of any input conditions.							
Level of Risk	Low consequence of settlement			High Consequence of settlement			
Surface Environment	Landscaping or Trees	Under rivers or lakes where settlement is not a problem		Environmentally sensitive or difficult to access areas			
Road/Rail Hierarchy Classification	Access roads (A)		Local Distributor (LD)	District Distributor B (DB) and Regional Distributor (RD)	District Distributor A (DA)	Primary Distributor (PD) Railway	
Geotechnical Conditions				Undetermined or unfavorable conditions including dry running sand, variable rock/sand, high ground water table.			
Minimum Requirements							
Allowable Trenchless Technique	Earth Pressure Balance Machine Boring						
	Pipe Jacking					Not Allowed	
Maximum overcut on pipe outside diameter	25mm	25mm	25mm	10mm	10mm	10mm	
Encasement pipe	Not Required	Not Required	Not Required	Not Required	Not Required	Not Required. However, for railways, the requirements shall be as per the railway authority.	
Quality Requirements	Geotechnical Investigation						
	Topographical Survey						
	Existing Services and Utilities Survey						
	Risk Assessment						
	Safety Management Plan						
	Environmental Impact Assessment						
	Methodology plan						
	Design Calculation						
	Installation Plan and Records						
				Onsite Drilling Engineer Required			
				Settlement Monitoring			
				Measurement of Soil Removal			
						Emergency Response Plan	
						Provision for grouting of outside of Encasement Pipe	
					Infrastructure Pre- and Post-Construction Conditions Report		

Table 4.10: PVC Pipeline Structural Requirements

DWV PVC-U Pipeline Component	Component Characteristics (Note 1)	Cover Depth to Top of Pipeline (Note 5)	
		≤ 7 metres	> 7 metres
Pipe	Ring-bending stiffness	≥ SN 6 (DN 100) ≥ SN 8 (DN 150 to DN 375)	≥ SN 16
RRJ Pipe Fittings (Notes 2/3/4)	Standard wall thickness	≥ T _{min} (DN 100 to DN 375)	Not permissible
	Heavy duty wall thickness	≥ T _{min} X 1.25 (DN 100/DN 150)	≥ T _{min} X 1.25 (DN 100 to DN 375)
SCJ Pipe Fittings (Notes 2/3/4)	Standard wall thickness	≥ T _{min} (DN 100 to DN 300)	Not permissible
	Heavy duty wall thickness	≥ T _{min} X 1.50 (DN 100/DN 150)	≥ T _{min} X 1.50 (DN 100 to DN 300)

Table 4.10 NOTES:

1. Pipe fittings shall be designed and selected on the basis of structural equivalence or better with the host pipe for the applicable cover depth.
2. For acceptability, the structural strength of fabricated and (fibreglass/other resin) reinforced or wrapped pipe fittings shall require the submission of engineering design and test evidence of an acceptable standard, across all wrapped pipe fitting sizes.
3. Baseline PVC pipe fitting wall thickness T_{min} means the minimum thickness values shown in Table 5.4 of AS/NZS 1260. Higher wall thickness values, being T_{min} X a minimum service factor of **1.25** for RRJ and **1.5** for SCJ fittings, shall apply to heavy duty (**HD**) pipe fittings, as and where required by DS 50.
4. These HD pipe fitting wall thickness values are equivalent to those required by WSAA product specification **WSA PS 230**. They are intended to mitigate fitting failure risks due to the application of abnormal shear, bending and torsional forces that, typically, arise due to ground movement, subsidence and differential settlement caused by poor (unsupervised and uncertified) installation - including backfill compaction - work quality and due also to excessively robust maintenance operations.
5. The nominated pipe and pipe fitting characteristics are minimum structural requirements that require the achievement by pipeline constructors of pipeline backfill densities that equal or exceed the minimum soil density ratio required by this standard. Non-conforming backfill material densities are likely to require thicker or specially reinforced pipe and pipe fittings or may need to be removed entirely and replaced with backfill materials of conforming density.

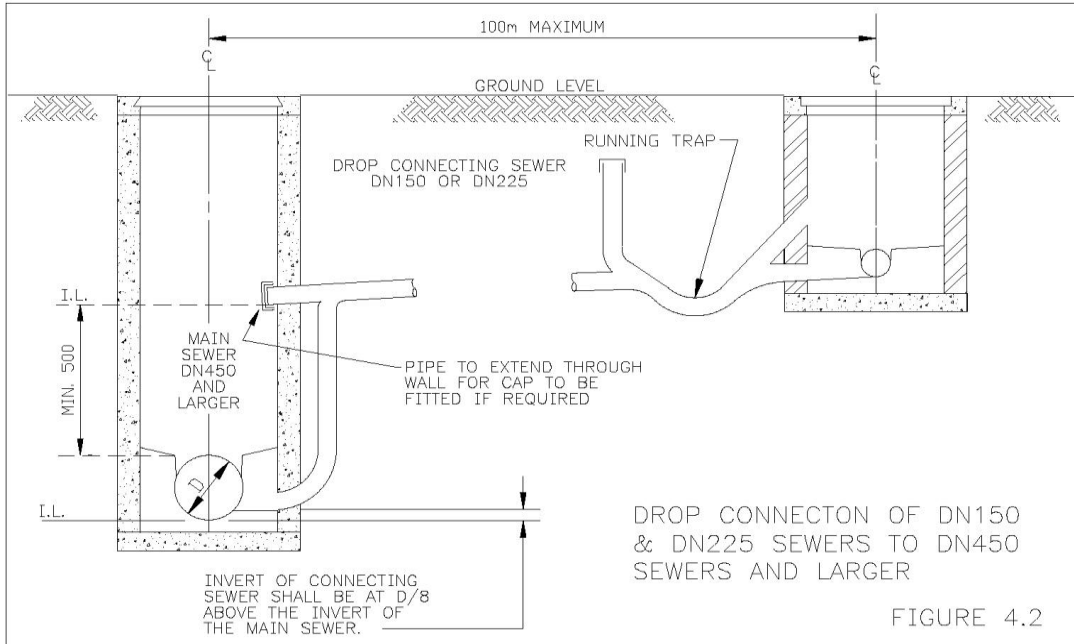
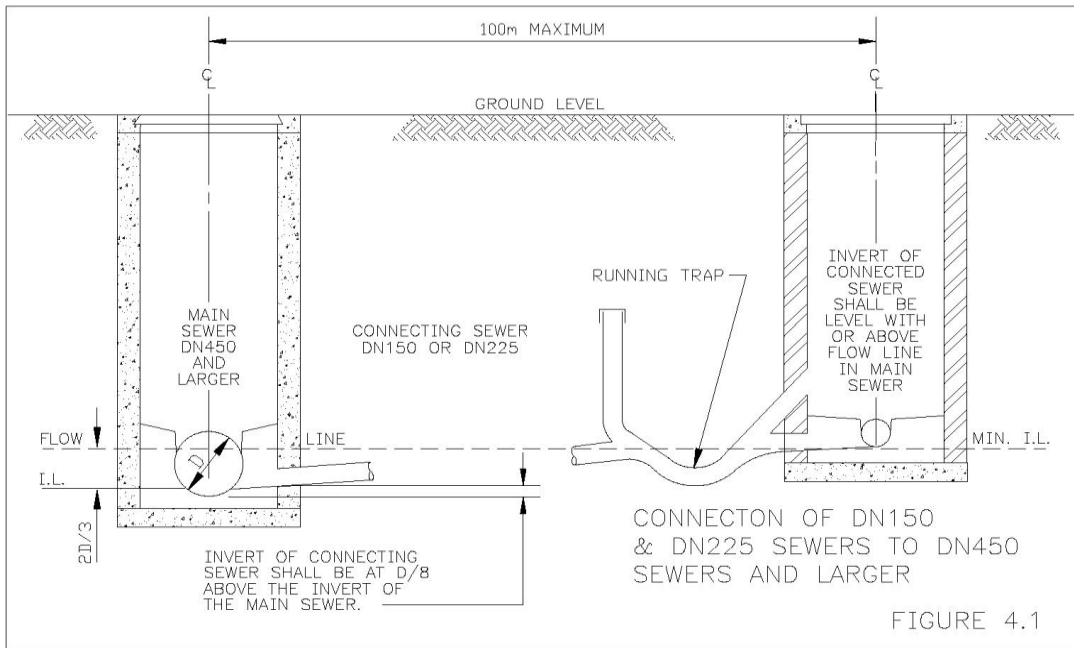

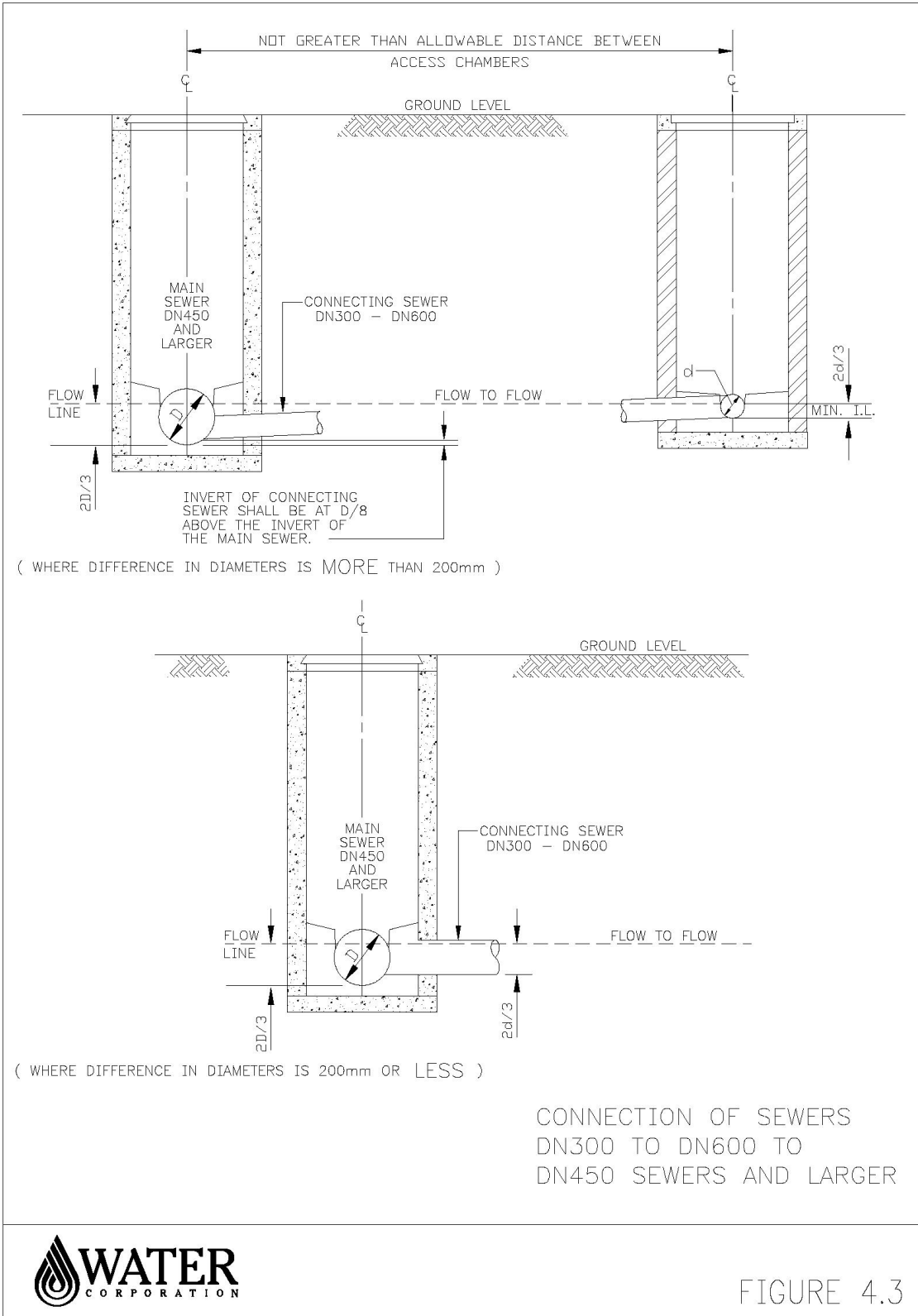
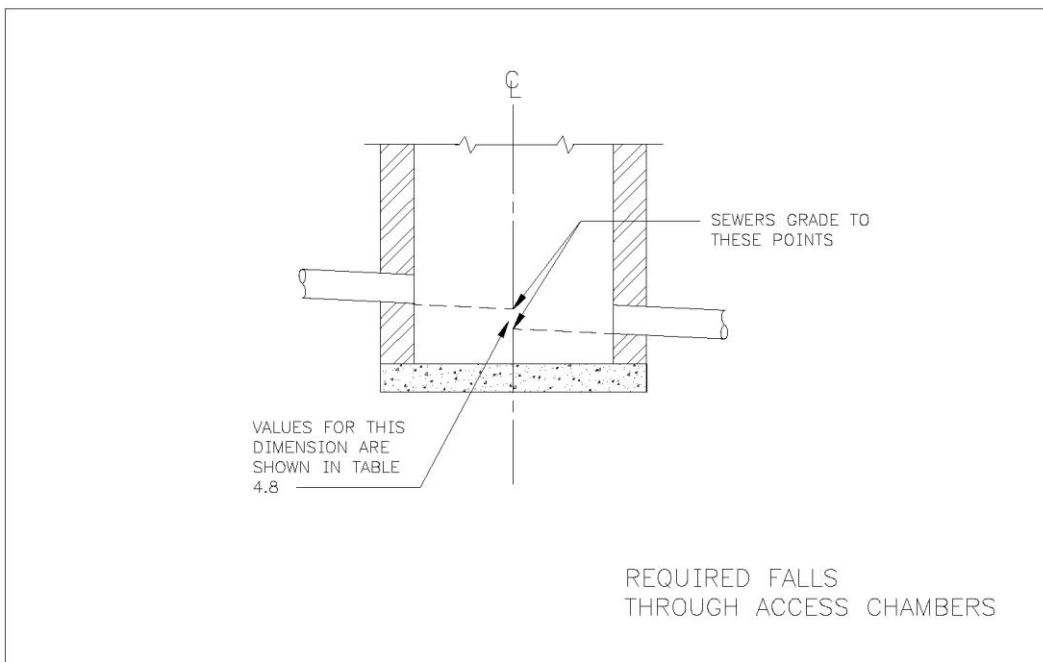

FIGURE 4.3



5 Construction Requirements

5.1 Introduction

5.1.1 General

- a. This Part of the Standard specifically refers to works being undertaken by a Developer for eventual take-over by the Water Corporation. Construction of works undertaken by the Water Corporation shall also follow the general principles of these requirements.
- b. Work shall be carried out in accordance with the requirements of this Standard and the relevant Acts and By-laws.

5.1.2 PVC Pipelaying Authorisation

PVC pipelaying personnel shall be trained in PVC pipelaying installation and handling. The training required shall be the successful completion of an acceptable PVC pipelaying and handling course conducted by the following training providers:

- South Metropolitan TAFE (SMTAFE)
- Civil Contractors Federation or
- Other equivalent training provider acceptable to the Water Corporation

Trained personnel shall be nominated at the “Start Up” meeting. The Water Corporation shall be notified of any change to PVC pipelaying personnel no later than one working day before any such change. No PVC pipelaying shall take place on any part of a project by an untrained PVC pipe-layer.

5.2 Construction Requirements

5.2.1 General

- a. Admixtures proposed for concrete work shall be subject to the prior approval of the Water Corporation. Admixtures which contain chloride or chloride-ions shall not be used. All concrete admixtures shall comply with AS 1478 and the procedure for the admixture use shall be in accordance with AS 1479. Admixtures shall not be used in lieu of Portland cement.
- b. The use of sealants or similar products to correct leakage as a result of construction faults is not permitted.

5.2.2 Pipelaying

- a. The displacement of any sewer pipeline from the alignments and levels shown on the design drawings shall be such that:
 - i. The horizontal shift of a sewer pipeline position from the nominated pipeline location should not exceed 150mm.
 - ii. The horizontal deviation of a sewer pipeline from the nominated straight line shall not exceed one tenth of the nominal sewer diameter at any point.
 - iii. The invert level of any part of a constructed sewer pipeline shall not vary by more than 10mm from the designed invert level as shown or as calculated from the information on the design drawings.
 - iv. The vertical shift or deviation in a sewer grade shall not result in a grade which will be flatter than 1.1 times the grade shown on the design drawings.
 - v. No part of a constructed sewer pipeline shall have a grade in the reverse slope direction to that shown on the design drawings.

- vi. No deviation of the diameter or circularity in any direction of a PVC sewer shall exceed 3% of the mean internal diameter as specified in the manufacturer's printed pipe manufacturing specification.
- b. Where a sewer crosses over existing services, the sewer shall be supported as required by the other service provider

5.2.3 Movement Joints

Joints shall be provided close to Access Chambers on flexibly jointed pipelines to allow for movement between the Access Chamber and the sewer pipeline.

5.2.4 Property Connections

- a. Property connections shall extend a distance of 0.5m inside the property being served.
- b. A property connection shall not pass through more than one property in addition to the property being served.
- c. The location of the end of property connections shall be subject to field adjustment to suit existing buildings or other on-site factors.
- d. Property connections shall be brought up to within 1.0m of the surface.
- e. Property connections shall include boundary traps where required.

5.2.5 Earthworks

If fill is required above the natural ground surface it shall be placed and compacted before the construction of the sewer unless the top of the sewer is 1.0 m or more below the natural surface. The fill may then be placed after the sewer has been constructed and the sewer shall be re-tested on completion of the placement and compaction of the fill.

5.2.6 Embedment

Embedment comprises the bedding, side support and overlay.

Bedding is the portion of the embedment zone between the foundation and the bottom of the pipe.

Pipelines shall be constructed on a continuous stable bedding of minimum thickness 150mm, extending for the full width of the trench as shown in the pipe trench zoning detail in the Drawings.

Where the bottom of the trench consists of material suitable for bedding, the pipe bedding shall be the undisturbed or compacted bottom of the trench.

Side support is the portion of the embedment zone to the side of the pipe between the bottom and top of the pipe.

Overlay is the portion of the embedment zone that is directly over the top of the pipe. The overlay shall be installed to a thickness of 0.15m for DN900 or smaller.

- a. Embedment materials shall be sand and shall:
 - i. be free of organic materials;
 - ii. be free of materials that would be harmful to a pipe or its protective coating;
 - iii. not contain particles larger than 7mm;
 - iv. not contain more than 12% fines by weight;
 - v. be imported if the above criteria cannot be met.
- b. Coarse aggregate may be used as the bedding material for lengths of trench requiring extensive dewatering. Aggregate bedding shall be made impervious to the siltation of sand or fines into the voids

in the bedding matrix by wrapping the aggregate bedding in A14 type geotextile fabric capable of preventing migration of sand into the aggregate, with 500 mm overlap of the edges of the geotextile.

- c. Pipe embedment materials shall be compacted to a density ratio of not less than 95% of maximum modified dry density as determined by AS 1289.5.2.1, AS 1289.5.8.1 and AS 1289.5.4.1.

5.2.7 Trench Fill

Trench fill is the refilling of trenches/excavations from the top of the pipe overlay to ground level in non-trafficable areas or to sub-grade level in trafficable areas, as shown in the pipe trench zoning detail in the Drawings.

5.2.7.1 Trench Fill under trafficable areas

- a. Backfill material under all trafficable areas (including existing gravel and limestone pavements and driveways) shall be sand and shall:
 - i. be free of organic materials;
 - ii. not contain particles larger than 37.5mm;
 - iii. not contain more than 12% fines by weight;
 - iv. be imported if the above criteria cannot be met.
- b. Trench fill placed within 4 m of the centreline of any road reserve (which has no pavement in place) and under all other trafficable areas, Trench fill shall be placed in loose layers not exceeding 250mm thickness and shall be compacted to a density ratio of not less than 95% of maximum modified dry density as determined by AS 1289.5.2.1, AS 1289.5.8.1 and AS 1289.5.4.1. Base-course and sub-base materials shall be reinstated and compacted to a minimum modified density ratio of 95%.

5.2.7.2 Trench Fill under non trafficable areas

- a. Trench fill material suitable for non-trafficable areas shall be excavated material and shall:
 - i. be free of organic materials;
 - ii. not contain particles or clay lumps larger than 200mm;
 - iii. be imported if the above criteria cannot be met.
 - Excavated material (including clay/clayey soils) shall not be deemed unsuitable due to its moisture content, unless otherwise directed by the *Superintendent*.
- b. Trench fill of excavated material under non trafficable areas for excavations in road verges, public open spaces, under paved areas in private property and within 2.0 m of a residence, building or retaining wall shall be placed in loose layers not exceeding 300 mm thickness for clay/cohesive materials or 400mm loose thickness for sand/gravel/cohesionless material and shall be compacted to a minimum density ratio of 92% of maximum modified dry density as determined by AS 1289.5.2.1, AS 1289.5.8.1 and AS 1289.5.4.1. For all other backfill in private property the compaction shall achieve the density of the surrounding ground (with a minimum of 87% modified dry density ratio in accordance with AS 1289.5.4.1).
 - The final 200mm of backfill material in parks, gardens and bushland shall be the topsoil material removed and stockpiled during stripping.

5.2.8 Restoration

Damage to property shall be reinstated at the Contractor's cost to a condition as near as practicable to that which existed prior to the commencement of work and to the satisfaction of the property owner.

5.3 Testing Requirements

5.3.1 General

To demonstrate compliance with the testing requirements of this Standard all equipment used for testing shall be accredited annually by a member of the National Association of Testing Authorities (NATA). Current accreditation certificates shall be available wherever the equipment is being used.

- a. Sewers DN100 to DN300 and maintenance shafts shall be either hydrostatically or air tested for leakage. Sewers DN375 and larger shall be visually inspected for infiltration, hydrostatic or air testing of these sewers is not required.
- b. Sewers, Access Chambers and Maintenance Shafts shall be checked for visible infiltration. If infiltration is found, the pipe, Maintenance Shaft or external face of the Access Chamber wall shall be uncovered at the point of leakage, unless otherwise authorised by the Water Corporation, and repaired.
- c. Sewers shall be tested for straightness in the horizontal and vertical directions and for freedom from obstructions.
- d. Sewers shall be tested by the Contractor prior to backfill.

5.3.2 Hydrostatic Testing of Pipelines

- a. PVC pipelines DN100 to DN300 shall be subjected to a head of water not less than 1.0m above ground level at the highest point of the section being tested but not more than 5.0m above the lowest point of the test section.

The test shall be maintained without leakage for at least 15 minutes.

If leakage occurs the pipeline shall be examined for leaks and any defects repaired. The pipeline shall then be retested.

- b. VC Pipelines DN100 to DN300 shall be subjected to a head of water not less than 3m above the pipe axis for a period of up to 24 hours.
 - i. The leakage shall not exceed a total of 10 litres / 100mm of pipe diameter / 30m length/hour.
 - ii. The allowable leakage rate can be adjusted proportionally to suit the pipe diameter, length, time and minimum head of water used in the test.

5.3.3 Air Testing of Pipelines

- a. PVC pipelines DN100 to DN300 shall be slowly pressurised to 50kPa. This pressure shall be maintained for at least 3 minutes and a check made for any leaks.
- b. If leaks are not apparent the air supply should be shut off and, provided that the pressure of the air in the pipes does not fall below 35kPa within 60 seconds, the pipeline shall be considered satisfactory.
- c. If the pressure falls below the specified limit, then air shall be re-introduced and the pipeline examined for leaks. Any defects found shall be rectified and the pipeline retested.
- d. VC pipelines DN100 to DN300 shall be pressurised by a suitable means (e.g. a hand pump) until a pressure of 100 mm of water is indicated in a glass U-tube connected to the system.
- e. For a satisfactory test the air pressure shall not fall to less than 75 mm of water over a period of 5 minutes without further pumping after allowing a suitable time for stabilization of the air temperature.
- f. Failure to pass the above air tests is not necessarily conclusive and if failure does occur a hydrostatic test may be carried out as an alternative to further air tests.

5.3.4 Ovality Testing of Pipelines

- a. DN150 to DN300 plain wall PVC pipes shall be tested for ovality using a 3% deflection gauge.

- b. The Water Corporation shall be provided with a letter certifying that all pipelines have passed an ovality test.
- c. Random ovality testing may be requested by the Water Corporation.
- d. Sewers between Access Chambers and Maintenance shafts shall be tested as follows.
 - i. If the ground is dry and no dewatering equipment is required during the excavation of the trenches the sewers can be tested for ovality 24 hours after the trenches have been backfilled.
 - ii. If the ground is wet and the level of the ground water is determined and recorded before excavation is commenced, the sewers can be tested for ovality 24 hours after the trenches have been backfilled and the ground water has regained its original level.
 - iii. If the level of the ground water is not determined and recorded before excavation is commenced, sewers shall not be tested until at least 14 days after backfilling of trenches.
- e. IO and IS sewers shall be tested immediately after the sewer has been constructed and the trench backfilled to the maximum amount possible, consistent with keeping the end of the trench open.
- f. Where a section of sewer fails the test, the failed section shall be removed and the sewer replaced. Repair couplings shall be concrete encased with the concrete encasing extending 150mm past the ends of the couplings.

5.3.5 Infiltration in Concrete Access Chambers

- a. An Access Chamber shall be considered to be leaking if any beads of water which appear on the Access Chamber's internal wall grow or run or if drops of water which appear at any joint fall from the joint at the rate of more than one drop per minute.
- b. Moisture appearing on the internal surface of the Access Chamber in the form of damp patches shall not be considered leakage.

5.3.6 Continuity Testing of Plastic Lining

- a. Continuity Spark testing of PVC lined products shall be carried out in accordance with AS 3894.1. It is important that procedures for testing, particularly the instrument stabilising period is followed.
- b. PVC lining on all reinforced concrete pipes and Access Chambers shall be continuity spark tested. The total area of PVC plastic lining shall be tested and for pipes, this shall be done as each pipe is laid.
- c. For DN600 pipes an additional test on the total area of PVC plastic lining is required after plastic welding of the joints.
- d. Plasticised PVC sheeting (1.5 mm thick) and rigid PVC sheeting (3 mm thick) shall be tested to 12,000 volts plus or minus 1,000 volts.
- e. The Water Corporation shall be provided with a letter certifying that there are no flaws in the PVC lining.

5.4 Recording of As Constructed Data

- a. The Construction Engineer/Contract Superintendent shall be responsible for the survey and recording of the required As Constructed data and shall engage a Surveyor for the survey of alignments and levels on sewers and Access Chambers.
- b. Where necessary, as constructed information which will not be readily available after completion of the works, shall be recorded during construction.
- c. As Constructed data shall be submitted within eight weeks of the final handover inspection.

6 As Constructed Requirements

6.1 Introduction

- a. This part of the Standard explains the requirements for the submission of as constructed information for gravity sewers.
- b. For Developer funded projects, as constructed information shall be submitted as directed in the Developer's Manual.
- c. For work commissioned by the Water Corporation, as constructed information for gravity sewers shall be submitted as directed in the construction contract documentation.
- d. Before works will be taken over by the Water Corporation, as constructed information shall have been submitted in the required form.

6.2 Responsibilities

DEVELOPMENT SUBMISSIONS

- a. The responsibilities for the preparation, verification and submission of as constructed information for Developer funded projects shall be in accordance with the requirements of the Developer's Manual.

WATER CORPORATION COMMISSIONED

- a. The preparation of the as constructed information shall be in accordance with the requirements of this Standard (DS 50) and Standard DS 80
- b. The as constructed information shall be submitted to the Water Corporation by the Contractor as per the requirements of the Contract.

6.3 Submission Procedures

6.3.1 General

- a. The As Constructed plan shall be provided to the Asset Registration Section of the Asset Management Services (AMS) of the Water Corporation with the following information:
 - i. As-constructed information in accordance with the typical information provided in this manual and example drawing AA01-91-1.
 - ii. A DXF file of the final precalculated cadastral plan. The DXF file format shall be as shown in Table 6.1. The DXF file can be forwarded to the Water Corporation by Email at the following address: asset.registration@watercorporation.com.au

6.3.2 Capture of Information

When the above information has been received, the Asset Registration Section will input the relevant data into the System.

- a. Copies of the plans will be scanned. Any discrepancy between the information contained on the plans and actual construction of the works shall remain the responsibility of the Contractor.

6.4 As-constructed Information

6.4.1 Sewer Details

- a. The location of sewers shall be fixed by dimensions to the intersection points of sewer centre lines in Access Chambers, Maintenance Shafts, ends of IO sewers, centres of inspection shafts on IS sewers. Each point shall be fixed by at least two dimensions to cadastral boundaries.

- b. The following information shall be provided for all sewers.
- Diameter of pipe.
 - Pipe material.
 - Type of pipe joint.
 - Grade of sewer, calculated by dividing the horizontal distance between the points at which levels are taken by the differences in the sewer inlet levels at the internal faces of the Access Chamber walls, the centre of the Maintenance Shafts or end of sewer or centre of IS shaft.
 - Length of sewer measured between the centre of Access Chambers and Maintenance Shafts.
 - Length of IO sewer measured from the centre of Access Chambers and or Maintenance Shafts to the capped end of the sewer or centre of IS shaft.
 - Length of IS sewer measured from the intersection of sewer centrelines to the centre of the vertical inspection shaft.
 - Concrete encasement and steel sleeves with measurement fixing their locations to the downstream Access Point.
 - Invert levels at the internal faces of Access Chamber walls, centres of Maintenance Shafts and ends of sewers and at the inspection shaft on IS sewers.
 - Inlets to Access Chambers and Maintenance Shafts or stubs left for future extensions with the pipe diameter, pipe material and invert at the Access Chamber or Maintenance Shaft.
 - Tunnel portals and measurements fixing their location from the downstream Access Point.
 - The location of running traps shall be indicated.

6.4.2 Property Connections

- a. The location of property connections shall be indicated by a distance measured along the sewer from the centre point of the nearest downstream Access Chamber, Maintenance Shaft, IS sewer or IO sewer to the end of the connection projected back at right angles to the centre line of the sewer.
- b. The distances which connections are brought in and or brought up from the sewer centre line.
- c. The location of boundary traps shall be indicated.

6.4.3 Special Conditions

Where the following special conditions apply to the connection of a property, they shall be shown in the plan.

- Tight connection
- Limited connection
- Limited flow
- Controlled discharge
- Dormant sewer
- Abandoned or decommissioned sewers

6.4.4 Sewers in Large Lots

Where sewers pass through large lots, sufficient co-ordinates at Access Chambers and Maintenance Shafts based on the current Map Grid of Australia (refer to DS80) shall be given to fix their locations. When coordinates are provided the coordinate system must be specified.

6.4.5 Access Chambers and Maintenance Shafts

- a. The cover surface level of the Access Chambers and Maintenance Shafts shall be taken on the top edge of the cover frame above the downstream sewer.
- b. Other relevant details such as the following shall be shown on the as constructed plans.
 - Drop
 - Gate
 - Any special features
- c. Where a sewer passes through a stormwater Access Chamber the Access Chamber shall be shown with measurements fixing its location and the drainage access chamber denoted as “syphon drain”

TABLE 6.1

FORMAT FOR DXF FILES

DESCRIPTION	AUOCAD LAYER NAME	MICROSTATION LEVEL	COLOUR
ROAD CASEMENTS	LANCASE	21	PURPLE
INTERNAL LOT BOUNDARIES	LANINT	22	WHITE
LOT NUMBERS	LANNUM	3	GREEN
CROWN LOT NUMBERS	LNNUMC	5	CYAN
ROAD NAMES IF AVAILABLE	LANNAME	6	MAGENTA
CONTOURS	CONT	30	YELLOW

NOTES:

1. Digital file shall be in the current MGA (refer DS 80) coordinates
2. Only the final precalculated cadastral plan to be submitted
3. The extent of the file to be limited to the area of as constructed submitted

END OF DOCUMENT