

APPROXIMATE:
 WORKING CAPACITY = 1080L
 SPILL CAPACITY = 300L
 SILT CAPACITY = 600L

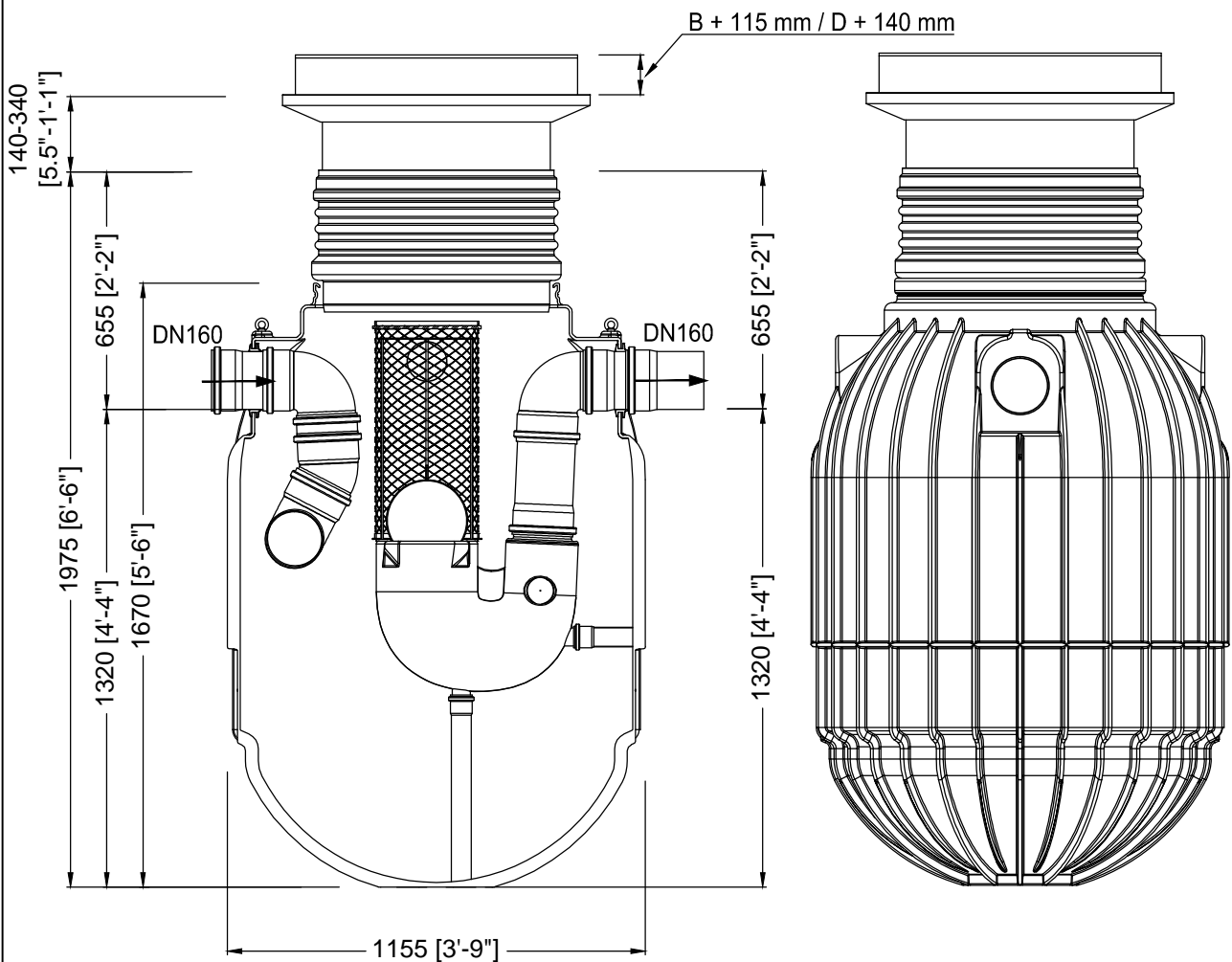

D GRAF LF-Abscheider KLsepa.compact+ NS 6 EX,SF: 600 L, KLASSE I, SAPHIR 1200 L			Artikel-Nr. product no. article no. 108107
GB Light liquid separator KLsepa.compact+ NS 6 EX,ST: 600 L, class I, SAPHIR 1200 L	ES Separador líquidos ligeros KLsepa.compact+ NS 6 EX,alm.lodos: 600 L, clase I, SAPHIR 1200 L	FR Séparateur liquides légers KLsepa.compact+ NS 6 EX,SF: 600 L, cl.I, SAPHIR 1200 L	revision
gezeichnet drawn ISC	Gewicht weight 110 kg	Otto Graf GmbH Carl-Zeiss-Str. 2-6 DE-79331 Teningen mail@graf.info www.graf.info	
Datum date 2017.08.01	Toleranz tolerance +/- 3%		
Maßstab scale M 1:20	Einheiten units mm [inch] gal. = US gal.		